

ALIN KANAL KATERLERİ



KOD	ÜRÜN AÇIKLAMASI	YEDEKLER	UÇ TİPİ	FİYATI
AK014	25x25 3C-L (030-040) Tmax 17	M8x26 A4 TCM 86	MGM 300 KRLY uca Uyumludur	1.468,00
AK015	25x25 3C-L (035-050) Tmax 17			1.468,00
AK016	25x25 3C-L (045-070) Tmax 17			1.468,00
AK017	25x25 3C-L (065-105) Tmax 17			1.468,00
AK018	25x25 3C-L (100-150) Tmax 17			1.468,00
AK019	25x25 4C-L (030-040) Tmax 17			MGM 400 KRLY uca Uyumludur
AK020	25x25 4C-L (035-050) Tmax 17		1.468,00	
AK021	25x25 4C-L (045-070) Tmax 17		1.468,00	
AK022	25x25 4C-L (065-105) Tmax 17		1.468,00	
AK023	25x25 4C-L (100-150) Tmax 17		1.468,00	
AK024	25x25 5C-L (075-110) Tmax 17		MGM 500 KRLY uca Uyumludur	
AK025	25x25 5C-L (105-150) Tmax 17			1.468,00
AK026	25x25 5C-L (145-200) Tmax 17			1.468,00

ALIN KANAL KATERLERİ



KOD	ÜRÜN AÇIKLAMASI	YEDEKLER	UÇ TİPİ	FİYATI
AK030	25x25 3C-L (025-035) Tmax 17	M8x26 A4 TCM 86	ZT.D 3mm ZCC uca Uyumludur	1.468,00
AK031	25x25 3C-L (035-045) Tmax 17			1.468,00
AK032	25x25 3C-L (039-055) Tmax 17			1.468,00
AK033	25x25 3C-L (049-080) Tmax 17			1.468,00
AK034	25x25 3C-L (070-110) Tmax 25			1.468,00
AK035	25x25 3C-R (070-110) Tmax 17			ZT.D 4mm ZCC uca Uyumludur
AK036	25x25 3C-L (100-150) Tmax 17		1.468,00	
AK037	25x25 4C-L (040-060) Tmax 22		1.468,00	
AK038	25x25 4C-L (052-080) Tmax 22		1.468,00	
AK039	25x25 4C-L (072-110) Tmax 22		1.468,00	
AK040	25x25 4C-L (110-150) Tmax 22		1.468,00	
AK041	25x25 4C-L (140-200) Tmax 22		ZT.D 5mm ZCC uca Uyumludur	1.468,00
AK042	25x25 5C-L (055-095) Tmax 25			1.468,00
AK043	25x25 5C-L (085-140) Tmax 25			1.468,00
AK044	25x25 5C-L (130-200) Tmax 25			1.468,00

ALIN KANAL KATERLERİ



KOD	ÜRÜN AÇIKLAMASI	YEDEKLER	UÇ TİPİ	FİYATI
AK045	25x25 3C-R (030-040)Tmax 14 LKT	M8x26 A4 TCM 86	MGM 300 KRLY uca Uyumludur	1.468,00
AK046	25x25 3C-R (035-050)Tmax 14 LKT			1.468,00
AK047	25x25 3C-R (045-070)Tmax 14 LKT			1.468,00
AK048	25x25 3C-R (065-105)Tmax 14 LKT			1.468,00
AK049	25x25 3C-R (100-150)Tmax 14 LKT			1.468,00
AK050	25x25 3C-R (150-200)Tmax 14 LKT			1.468,00
AK051	25x25 3C-R (200-300)Tmax 14 LKT		MGM 400 KRLY uca Uyumludur	1.468,00
AK052	25x25 3C-R (300-500)Tmax 14 LKT			1.468,00
AK053	25x25 4C-R (035-050)Tmax 17 LKT			1.468,00
AK054	25x25 4C-R (045-070)Tmax 17 LKT			1.468,00
AK055	25x25 4C-R (065-105)Tmax 17 LKT			1.468,00
AK056	25x25 4C-R (100-150)Tmax 17 LKT			1.468,00
AK057	25x25 4C-R (150-200)Tmax 17 LKT			1.468,00

DIŞ ÇAP KESKİ KATERLERİ

KOD	ÜRÜN AÇIKLAMASI	YEDEKLER	UÇ TİPİ	FİYATI
DK001	16x16 1.5C-R T-max17	M8x26 A4 TCM 86	MGM 150 KRLY	963,00
DK002	20x20 1.5C-R T-max17			1.008,00
DK002-1	25x25 1.5C-R T-max18			1.048,00
DK003	12x12 2C-R T-max14	M5x16 A3 TCM 82	MGM 200 KRLY	923,00
DK004	16x16 2C-R T-max17	M8x26 A4 TCM 86		963,00
DK005	20x20 2C-R T-max17			1.008,00
DK006	25x25 2C-R T-max18			1.048,00
DK007	32x32 2C-R T-max21			1.262,00
DK008	12x12 3C-R T-max16			M5x16 A3 TCM 82
DK009	16x16 3C-R T-max18	M8x26 A4 TCM 86		963,00
DK010	20x20 3C-R T-max18		1.008,00	
DK011	25x25 3C-R T-max21		1.048,00	
DK011-1	25x25 3C-R T-max30		1.619,00	
DK011-2	25x25 3C-R T-max40	1.720,00		
DK012	32x32 3C-R T-max23	1.262,00		
DK013	16x16 4C-R T-max18	M8x26 A4 TCM 86	MGM 400 KRLY	963,00
DK014	20x20 4C-R T-max18			1.008,00
DK015	25x25 4C-R T-max22			1.048,00
DK015-1	25x25 4C-R T-max30			1.619,00
DK015-2	25x25 4C-R T-max40			1.720,00
DK016	32x32 4C-R T-max25			1.262,00
DK017	20x20 5C-R T-max21	M8x26 A4 TCM 86	MGM 500 KRLY	1.008,00
DK018	25x25 5C-R T-max21			1.048,00
DK018-1	25x25 5C-R T-max40			1.720,00
DK019	32x32 5C-R T-max25			1.262,00
DK020	25x25 6C-R T-max22	M8x26 A4 TCM 86	MGM 600 KRLY	1.048,00
DK021	32x32 6C-R T-max25			1.262,00

DIŞ ÇAP KESKİ KATERLERİ

DK029	12x12 2C-L T-max14	M5x16 A3 TCM 82	MGM 200 KRLY	923,00
DK030	16x16 2C-L T-max17	M8x26 A4 TCM 86		963,00
DK031	20x20 2C-L T-max17			1.008,00
DK032	25x25 2C-L T-max18			1.048,00
DK033	12x12 3C-L T-max16	M5x16 A3 TCM 82	MGM 300 KRLY	923,00
DK034	16x16 3C-L T-max18	M8x26 A4 TCM 86		963,00
DK035	20x20 3C-L T-max18			1.008,00
DK036	25x25 3C-L T-max21			1.048,00
DK037	16x16 4C-L T-max18		M8x26 A4 TCM 86	MGM 400 KRLY
DK038	20x20 4C-L T-max18	1.008,00		
DK039	25x25 4C-L T-max22	1.048,00		
DK041	25x25 5C-L T-max22	M8x26 A4 TCM 86	MGM 500	1.048,00
DK042	25x25 6C-L T-max22			MGM 600



DIŞ ÇAP KESKİ KATERLERİ

KOD	ÜRÜN AÇIKLAMASI	YEDEKLER	UÇ TİPİ	FİYATI
DK048	12x12 2C-R T-max14	M5x16 A3 TCM 82	DGN 2mm ISCR	923,00
DK049	16x16 2C-R T-max18	M8x26 A4 TCM 86		963,00
DK050	20x20 2C-R T-max18			1.008,00
DK051	25x25 2C-R T-max22			1.048,00
DK052	12x12 3C-R T-max14	M5x16 A3 TCM 82	DGN 3mm ISCR	923,00
DK053	16x16 3C-R T-max18	M8x26 A4 TCM 86		963,00
DK054	20x20 3C-R T-max18			1.008,00
DK055	25x25 3C-R T-max22			1.048,00
DK055-1	25x25 3C-R T-max40			1.720,00
DK056	32x32 3C-R T-max22			1.262,00
DK057	16x16 4C-R T-max18		M8x26 A4 TCM 86	DGN 4mm ISCR
DK058	20x20 4C-R T-max18	1.008,00		
DK059	25x25 4C-R T-max22	1.048,00		
DK059-1	25x25 4C-R T-max40	1.720,00		
DK060	32x32 4C-R T-max22	1.262,00		
DK061	20x20 5C-R T-max22	M8x26 A4 TCM 86	DGN 5mm ISCR	1.008,00
DK062	25x25 5C-R T-max22			1.048,00
DK063	32x32 5C-R T-max22			1.262,00
DK064	25x25 6C-R T-max22	M8x26 A4 TCM 86	DGN 6mm ISCR	1.048,00
DK065	32x32 6C-R T-max22			1.262,00



DIŞ ÇAP KESKİ KATERLERİ

DK068	12x12 2C-L T-max14	M5x16 A3 TCM 82	DGN 2mm ISCR	923,00
DK069	16x16 2C-L T-max18	M8x26 A4 TCM 86		963,00
DK070	20x20 2C-L T-max18			1.008,00
DK071	25x25 2C-L T-max22			1.048,00
DK072	12x12 3C-L T-max14	M5x16 A3 TCM 82	DGN 3mm ISCR	923,00
DK073	16x16 3C-L T-max18	M8x26 A4 TCM 86		963,00
DK074	20x20 3C-L T-max18			1.008,00
DK075	25x25 3C-L T-max22			1.048,00
DK076	16x16 4C-L T-max18		M8x26 A4 TCM 86	DGN 4mm ISCR
DK077	20x20 4C-L T-max18	1.008,00		
DK078	25x25 4C-L T-max22	1.048,00		
DK080	25x25 5C-L T-max22		DGN 5mm ISCR	1.048,00



DIŞ ÇAP KESKİ KATERLERİ

DK084	16x16 2C-R T-max20	M8x26 A4 TCM 86	S224 2mm K.HORN	963,00
DK085	20x20 2C-R T-max20			1.008,00
DK086	25x25 2C-R T-max22			1.048,00
DK087	16x16 3C-R T-max20		S224 3mm K.HORN	963,00
DK088	20x20 3C-R T-max20			1.008,00
DK089	25x25 3C-R T-max22			1.048,00
DK090	32x23 3C-R T-max22		1.262,00	



DIŞ ÇAP KESKİ KATERLERİ



KOD	ÜRÜN AÇIKLAMASI	YEDEKLER	UÇ TİPİ	FİYATI
DK091	16x16 4C-R T-max20	M8x26 A4 TCM 86	S224 4mm K.HORN	963,00
DK092	20x20 4C-R T-max20			1.008,00
DK093	25x25 4C-R T-max22			1.048,00
DK094	32x23 4C-R T-max22			1.262,00

DIŞ ÇAP KESKİ KATERLERİ

DK095	16x16 2C-L T-max20	M8x26 A4 TCM 86	S224 2mm K.HORN	963,00
DK096	20x20 2C-L T-max20			1.008,00
DK097	25x25 2C-L T-max22			1.048,00
DK098	16x16 3C-L T-max20		S224 3mm K.HORN	963,00
DK099	20x20 3C-L T-max20			1.008,00
DK100	25x25 3C-L T-max22			1.048,00
DK101	16x16 4C-L T-max20		S224 4mm K.HORN	963,00
DK102	20x20 4C-L T-max20			1.008,00
DK103	25x25 4C-L T-max22			1.048,00

DIŞ ÇAP KESKİ KATERLERİ

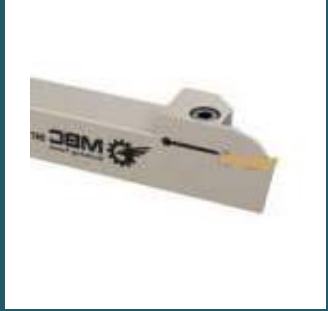
KOD	ÜRÜN AÇIKLAMASI	YEDEKLER	UÇ TİPİ	FİYATI
DK104	16x16 3C-R T-max22	M8x26 A4 TCM 86	S229 3mm B.HORN	963,00
DK105	20x20 3C-R T-max22			1.008,00
DK106	25x25 3C-R T-max23			1.048,00
DK107	32x32 3C-R T-max24			1.262,00
DK108	20x20 4C-R T-max22		S229 4mm B.HORN	1.008,00
DK109	25x25 4C-R T-max23			1.048,00
DK110	32x32 4C-R T-max24			1.262,00
DK111	20x20 5C-R T-max22		S229 5mm B.HORN	1.008,00
DK112	25x25 5C-R T-max23			1.048,00
DK114	32x32 5C-R T-max24			1.262,00
DK115	25x25 6C-R T-max23		S229 6mm B.HORN	1.048,00

DIŞ ÇAP KESKİ KATERLERİ

DK117	20x20 3C-L T-max22	M8x26 A4 TCM 86	S229 3mm B.HORN	1.008,00
DK118	25x25 3C-L T-max23			1.048,00
DK119	20x20 4C-L T-max22		S229 4mm B.HORN	1.008,00
DK120	25x25 4C-L T-max23			1.048,00
DK120-1	16x16 5C-L T-max22		S229 5mm B.HORN	963,00
DK121	20x20 5C-L T-max22			1.008,00
DK122	25x25 5C-L T-max23			1.048,00

DIŞ ÇAP KESKİ KATERLERİ

KOD	ÜRÜN AÇIKLAMASI	YEDEKLER	UÇ TİPİ	FİYATI
DK124	12x12 2C-R T-max14	M5x16 A3 TCM 82	TD 2mm TGTC	923,00
DK125	16x16 2C-R T-max18	M8x26 A4 TCM 86		963,00
DK126	20x20 2C-R T-max18			1.008,00
DK127	25x25 2C-R T-max21			1.048,00

DIŞ ÇAP KESKİ KATERLERİ



KOD	ÜRÜN AÇIKLAMASI	YEDEKLER	UÇ TİPİ	FİYATI
DK128	12x12 3C-R T-max14	M5x16 A3 TCM 82	TD 3mm TGTC	923,00
DK129	16x16 3C-R T-max18			963,00
DK130	20x20 3C-R T-max18			1.008,00
DK131	25x25 3C-R T-max21			1.048,00
DK132	32x32 3C-R T-max23			1.262,00
DK133	16x16 4C-R T-max18	M8x26 A4 TCM 86	TD 4mm TGTC	963,00
DK134	20x20 4C-R T-max18			1.008,00
DK135	25x25 4C-R T-max21			1.048,00
DK136	32x32 4C-R T-max23			1.262,00
DK137	25x25 5C-R T-max21			TD 5mm TGTC

DIŞ ÇAP KESKİ KATERLERİ



KOD	ÜRÜN AÇIKLAMASI	YEDEKLER	UÇ TİPİ	FİYATI
DK138	16x16 2C-R T-max17	M8x26 A4 TCM 86	ZT.D 2mm ZCC	963,00
DK139	20x20 2C-R T-max17			1.008,00
DK140	25x25 2C-R T-max21		1.048,00	
DK142	20x20 2,5C-R T-max17		ZT.D 2.5mm ZCC	1.008,00
DK143	25x25 2,5C-R T-max21			1.048,00
DK144	16x16 3C-R T-max18		ZT.D 3mm ZCC	963,00
DK145	20x20 3C-R T-max18			1.008,00
DK146	25x25 3C-R T-max21			1.048,00
DK147	16x16 4C-R T-max18		ZT.D 4mm ZCC	963,00
DK148	20x20 4C-R T-max18			1.008,00
DK149	25x25 4C-R T-max21	1.048,00		
DK150	32x32 4C-R T-max25	1.262,00		
DK151	16x16 5C-R T-max18	ZT.D 5mm ZCC	963,00	
DK152	20x20 5C-R T-max21		1.008,00	
DK153	25x25 5C-R T-max22		1.048,00	
DK154	32x32 5C-R T-max25		1.262,00	
DK155	20x20 6C-R T-max21	ZT.D 6mm ZCC	1.008,00	
DK156	25x25 6C-R T-max22		1.048,00	
DK157	32x32 6C-R T-max25		1.262,00	

DIŞ ÇAP KESKİ KATERLERİ



DK167	16x16 2C-L T-max17	M8x26 A4 TCM 86	ZT.D 2mm ZCC	963,00
DK168	20x20 2C-L T-max17			1.008,00
DK169	25x25 2C-L T-max21			1.048,00
DK172	25x25 2,5C-L T-max21		ZT.D 2,5mm ZCC	1.048,00
DK173	16x16 3C-L T-max18		ZT.D 3mm ZCC	963,00
DK174	20x20 3C-L T-max18			1.008,00
DK175	25x25 3C-L T-max21			1.048,00

DIŞ ÇAP KESKİ KATERLERİ

KOD	ÜRÜN AÇIKLAMASI	YEDEKLER	UÇ TİPİ	FİYATI
DK176	16x16 4C-L T-max18	M8x26 A4 TCM 86	ZT.D 2mm ZCC	963,00
DK177	20x20 4C-L T-max18			1.008,00
DK178	25x25 4C-L T-max21			1.048,00
DK179	16x16 5C-L T-max18		ZT.D 2mm ZCC	963,00
DK180	20x20 5C-L T-max21			1.008,00
DK181	25x25 5C-L T-max22			1.048,00

DIŞ ÇAP KESKİ KATERLERİ

KOD	ÜRÜN AÇIKLAMASI	YEDEKLER	UÇ TİPİ	FİYATI
DK182	16x16 1,5C-R T-max18	M8x26 A4 TCM 86	N123 1.5mm SNDV	963,00
DK183	20x20 1,5C-R T-max18			1.008,00
DK184	25x25 1,5C-R T-max18			1.048,00
DK185	12x12 2C-R T-max12	M5x16 A3 TCM 82	N123 2mm SNDV	923,00
DK186	16x16 2C-R T-max18	M8x26 A4 TCM 86		963,00
DK187	20x20 2C-R T-max18			1.008,00
DK188	25x25 2C-R T-max21		1.048,00	
DK189	12x12 3C-R T-max12	M5x16 A3 TCM 82	N123 3mm SNDV	923,00
DK190	20x20 3C-R T-max18	M8x26 A4 TCM 86		1.008,00
DK191	25x25 3C-R T-max21			1.048,00
DK192	20x20 4C-R T-max20		M8x26 A4 TCM 86	N123 4mm SNDV
DK193	25x25 4C-R T-max21	1.048,00		
DK194	20x20 5C-R T-max21	N123 5mm SNDV		1.008,00
DK195	25x25 5C-R T-max23		1.048,00	
DK196	32x32 5C-R T-max25		1.262,00	

DIŞ ÇAP KESKİ KATERLERİ

DK201	16x16 2C-L T-max18	M8x26 A4 TCM 86	N123 2mm SNDV	963,00
DK202	20x20 2C-L T-max18			1.008,00
DK203	25x25 2C-L T-max21			1.048,00
DK206	25x25 3C-L T-max21		N123 3mm SNDV	1.048,00

DIŞ ÇAP KESKİ KATERLERİ

KOD	ÜRÜN AÇIKLAMASI	YEDEKLER	UÇ TİPİ	FİYATI
DK211	12x12 2C-R T-max12	M5x16 A3 TCM 82	GDM 2mm KYCR	923,00
DK212	16x16 2C-R T-max17	M8x26 A4 TCM 86		963,00
DK213	20x20 2C-R T-max17			1.008,00
DK214	25x25 2C-R T-max18			1.048,00
DK215	12x12 3C-R T-max12		M5x16 TCM 82	GDM 3mm KYCR
DK216	16x16 3C-R T-max20	M8x26 A4 TCM 86	963,00	
DK217	20x20 3C-R T-max20		1.008,00	
DK218	25x25 3C-R T-max21		1.048,00	
DK218-1	25x25 3C-R T-max25		1.048,00	
DK219	16x16 4C-R T-max17		GDM 4mm KYCR	963,00
DK220	25x25 4C-R T-max25	1.048,00		

DIŞ ÇAP KESKİ KATERLERİ



KOD	ÜRÜN AÇIKLAMASI	YEDEKLER	UÇ TİPİ	FİYATI
DK220-1	16x16 2C-L T-max17	M8x26 A4 TCM 86	GDM 2mm KYCR	963,00
DK220-2	20x20 2C-L T-max17			1.008,00
DK221	25x25 2C-L T-max18			1.048,00
DK222	16x16 3C-L T-max20		GDM 3mm KYCR	963,00
DK223	20x20 3C-L T-max20			1.008,00
DK224	25x25 3C-L T-max25			1.048,00

DIŞ ÇAP KESKİ KATERLERİ



KOD	ÜRÜN AÇIKLAMASI	YEDEKLER	UÇ TİPİ	FİYATI
DK225	16x16 2C-R T-max18	M8x26 A4 TCM 86	A4 GMN 2mm KNMT	963,00
DK226	20x20 2C-R T-max18			1.008,00
DK227	25x25 2C-R T-max22			1.048,00
DK228	20x20 3C-R T-max18		A4 GMN 3mm KNMT	1.008,00
DK229	25x25 3C-R T-max22			1.048,00
DK230	20x20 4C-R T-max18			A4 GMN 4mm KNMT
DK231	25x25 4C-R T-max22		1.048,00	
DK232	25x25 5C-R T-max22		A4 GMN 5mm KNMT	1.048,00
DK233	25x25 6C-R T-max22		A4 GMN 6mm KNMT	1.048,00

DIŞ ÇAP KESKİ KATERLERİ



KOD	ÜRÜN AÇIKLAMASI	YEDEKLER	UÇ TİPİ	FİYATI
DK234	16x16 2C-R T-max17	M8x26 A4 TCM 86	TNG 2mm TNGLY	963,00
DK235	20x20 2C-R T-max20			1.008,00
DK236	25x25 2C-R T-max22			1.048,00

DIŞ ÇAP KESKİ KATERLERİ



KOD	ÜRÜN AÇIKLAMASI	YEDEKLER	UÇ TİPİ	FİYATI
DK250	20x20 2C-R T-max20	M8x26 A4 TCM 86	VGD 2mm VARG	1.008,00
DK251	25x25 2C-R T-max20			1.048,00
DK252	20x20 3C-R T-max20		VGD 3mm VARG	1.008,00
DK253	25x25 3C-R T-max22			1.048,00
DK254	32x32 3C-R T-max24			1.262,00
DK255	25x25 4C-R T-max22		VGD 4mm VARG	1.048,00
DK256	32x32 4C-R T-max24			1.262,00

DIŞ ÇAP KESKİ KATERLERİ



KOD	ÜRÜN AÇIKLAMASI	YEDEKLER	UÇ TİPİ	FİYATI
DK257	16x16 1C H360	M5x12 KEP 13 M4x9x5,4 TCM 40	S312 1mm HORN	963,00
DK258	20x20 1C H360			1.008,00
DK259	25x25 1C H360			1.048,00
DK260	16x16 2C H360		S312 2mm HORN	963,00
DK261	20x20 2C H360			1.008,00
DK262	25x25 2C H360			1.048,00
DK263	16x16 3C H360		S312 3mm HORN	963,00
DK264	20x20 3C H360			1.008,00
DK265	25x25 3C H360			1.048,00

KESKİ KATERİ KAYAR OTO.

KOD	ÜRÜN AÇIKLAMASI	YEDEKLER	UÇ TİPİ	FİYATI
DK269	12x12 2C-R T-max12 KAY.OT.	M4x16x5.5 TCM 44	DGN 2mm	963,00
DK270	16x16 2C-R T-max15 KAY.OT.		ISCR	1.008,00
DK271	12x12 3C-R T-max12 KAY.OT.		DGN 3mm	963,00
DK272	16x16 3C-R T-max15 KAY.OT.		ISCR	1.008,00

KESKİ KATERİ KAYAR OTO.

DK276	12x12 2C-L T-max12 KAY.OT.	M4x16x5.5 TCM 44	DGN 2mm	963,00
DK277	16x16 2C-L T-max15 KAY.OT.		ISCR	1.008,00
DK278	12x12 3C-L T-max12 KAY.OT.		DGN 3mm	963,00
DK279	16x16 3C-L T-max15 KAY.OT.		ISCR	1.008,00

KESKİ KATERİ KAYAR OTO.

KOD	ÜRÜN AÇIKLAMASI	YEDEKLER	UÇ TİPİ	FİYATI
DK281	12x12 1.5C-R T-max12 KAY.OT.	M4x16x5.5 TCM 44	N123 1.5mm	963,00
DK282	16x16 1.5C-R T-max15 KAY.OT.		SNDV	1.008,00
DK283	12x12 2C-R T-max12 KAY.OT.		N123 2mm SNDV	963,00
DK284	12x12 3C-R T-max12 KAY.OT.		N123 2mm SNDV	963,00

KESKİ KATERİ KAYAR OTO.

DK286	12x12 1.5C-L T-max12 KAY.OT.	M4x16x5.5 TCM 44	N123 1.5mm	963,00
DK287	16x16 1.5C-L T-max15 KAY.OT.		SNDV	1.008,00
DK288	12x12 2C-L T-max12 KAY.OT.		N123 2mm SNDV	963,00
DK289	12x12 3C-L T-max12 KAY.OT.		N123 3mm SNDV	963,00

KESKİ KATERİ KAYAR OTO.

KOD	ÜRÜN AÇIKLAMASI	YEDEKLER	UÇ TİPİ	FİYATI
DK290	10x10 2C-R T-max12 KAY.OT.	M4x16x5.5 TCM 44	GDM 2mm	963,00
DK291	12x12 2C-R T-max12 KAY.OT.		KYCR	963,00
DK292	16x16 2C-R T-max15 KAY.OT.			1.008,00
DK293	12x12 3C-R T-max12 KAY.OT.		GDM 3mm	963,00
DK294	16x16 3C-R T-max15 KAY.OT.		KYCR	1.008,00

KESKİ KATERİ KAYAR OTO.

DK295	10x10 2C-L T-max12 KAY.OT.	M4x16x5.5 TCM 44	GDM 2mm	963,00
DK296	12x12 2C-L T-max12 KAY.OT.		KYCR	963,00
DK297	16x16 2C-L T-max15 KAY.OT.			1.008,00
DK298	12x12 3C-L T-max12 KAY.OT.		GDM 3mm	963,00
DK299	16x16 3C-L T-max15 KAY.OT.		KYCR	1.008,00

KESKİ KATERİ KAYAR OTO.

DK300	12x12 2C-R T-max12 KAY.OT.	M4x16x5.5 TCM 44	ZT.D 2mm	963,00
DK301	16x16 2C-R T-max15 KAY.OT.		ZCC	1.008,00
DK302	12x12 3C-R T-max12 KAY.OT.		ZT.D 3mm	963,00
DK303	16x16 3C-R T-max15 KAY.OT.		ZCC	1.008,00

KESKİ KATERİ KAYAR OTO.

DK304	12x12 2C-L T-max12 KAY.OT.	M4x16x5.5 TCM 44	ZT.D 2mm	963,00
DK305	16x16 2C-L T-max15 KAY.OT.		ZCC	1.008,00
DK306	12x12 3C-L T-max12 KAY.OT.		ZT.D 3mm	963,00
DK307	16x16 3C-L T-max15 KAY.OT.		ZCC	1.008,00

DIŞ ÇAP KESKİ KATERLERİ



KOD	ÜRÜN AÇIKLAMASI	YEDEKLER	UÇ TİPİ	FİYATI
PEN02	PCHR 12x12 -24 PENTA	M4.5x12x6.5 TCM 87	PEN 24 ISCR	1.008,00
PEN04	PCHR 16x16 -24 PENTA			1.008,00
PEN06	PCHR 20x20 -24 PENTA			1.037,00
PEN08	PCHR 25x25 -24 PENTA			1.037,00
PEN10	PCHR 20x20 -34 PENTA	M5x15x6.5 TCM 47	PEN 34 ISCR	1.037,00
PEN12	PCHR 25x25 -34 PENTA			1.037,00
PEN14	PCHL 12x12 -24 -SOL PENTA	M4.5x12x6.5 TCM 87	PEN 24 ISCR	1.008,00
PEN16	PCHL 16x16 -24 -SOL PENTA			1.008,00
PEN18	PCHL 20x20 -24 -SOL PENTA			1.037,00
PEN20	PCHL 25x25 -24 -SOL PENTA			1.037,00
PEN22	PCHL 20x20 -34 -SOL PENTA	M5x15x6.5 TCM 47	PEN 34 ISCR	1.037,00
PEN24	PCHL 25x25 -34 -SOL PENTA			1.037,00

LAMA TUTUCULARI



KOD	ÜRÜN AÇIKLAMASI	FİYATI
LTT001	KESME LAMA TUTUCU 20-20 -26	1.600,00
LTT002	KESME LAMA TUTUCU 20-20 -32	1.600,00
LTT003	KESME LAMA TUTUCU 25-25 -26	1.650,00
LTT004	KESME LAMA TUTUCU 25-25 -32	1.700,00
LTT005	KESME LAMA TUTUCU 32-32 -32	1.800,00

KESME LALALARI



KOD	ÜRÜN AÇIKLAMASI	UÇ TİPİ	FİYATI
MBL04	26-3 KESME LAMASI	DGN 3mm ISCR	1.100,00
MBL10	32-3 KESME LAMASI		1.225,00
MBL16	26-3 KESME LAMASI	MGM 300 KRLY	1.100,00
MBL22	32-3 KESME LAMASI		1.274,00
MBL28	26-3 KESME LAMASI	ZT-D 3mm ZCC	1.100,00
MBL34	32-3 KESME LAMASI		1.274,00

İÇ KANAL KATERLERİ



KOD	ÜRÜN AÇIKLAMASI	YEDEKLER	UÇ TİPİ	FİYATI
İK001	S16Q 2C T-max4	M4x12 A3 TCM 80	MGM 200 KRLY	880,00
İK002	S20R 2C T-max4			923,00
İK003	S25S 2C T-max5.5	M6x16 A5 TCM 84		1.008,00
İK004	S32S 2C T-max6	M8x26 A4 TCM 86		1.110,00
İK005	S20R 3C T-max4.5	M4x12 A3 TCM 80 M6x16 A5 TCM 84	MGM 300 KRLY	923,00
İK006	S25S 3C T-max6			1.008,00
İK007	S32S 3C T-max9	M8x26 A4 TCM 80		1.110,00
İK008	S40U 3C T-max10			1.833,00
İK009	S20R 4C T-max4.5	M4x12 A3 TCM 80 M6x16 A5 TCM 84	MGM 400 KRLY	923,00
İK010	S25S 4C T-max6			1.008,00
İK011	S32S 4C T-max9	M8x26 A4 TCM 80		1.110,00
İK012	S40U 4C T-max10			1.833,00
İK013	S25S 5C T-max6	M6x16 A5 TCM 84 M8x26 A4 TCM 80	MGM 500 KRLY	1.008,00
İK014	S32S 5C T-max9			1.110,00
İK015	S40U 5C T-max10	1.833,00		

İÇ KANAL KATERLERİ

KOD	ÜRÜN AÇIKLAMASI	YEDEKLER	UÇ TİPİ	FİYATI
İK017	S20R 2C T-max4.5	M4x12 A3 TCM 80	DGN 2mm ISCR	923,00
İK018	S25S 2C T-max6	M6x16 A5 TCM 84		1.008,00
İK019	S32S 2C T-max8.5	M8x26 A4 TCM 86		1.110,00
İK020	S20R 3C T-max4.5	M4x12 A3 TCM 80	DGN 3mm ISCR	923,00
İK021	S25S 3C T-max6	M6x16 A5 TCM 84		1.008,00
İK022	S32S 3C T-max8.5	M8x26 A4 TCM 86		1.110,00
İK023	S20R 4C T-max4.5	M4x12 A3 TCM 80	DGN 4mm ISCR	923,00
İK024	S25S 4C T-max6	M6x16 A5 TCM 84		1.008,00
İK025	S32S 4C T-max8.5	M8x26 A4 TCM 86		1.110,00

İÇ KANAL KATERLERİ

KOD	ÜRÜN AÇIKLAMASI	YEDEKLER	UÇ TİPİ	FİYATI
İK026	S16Q 3C T-max4	M4x12 A3 TCM 80	TGM 3mm ISCR	880,00
İK027	S20R 3C T-max4			923,00
İK028	S25S 3C T-max5.5	M6x16 A5 TCM 84		1.008,00
İK029	S32S 3C T-max9	M8x26 A4 TCM 86	1.110,00	
İK030	S25S 4C T-max5.5	M6x16 A5 TCM 84	TGM 4mm ISCR	1.008,00
İK031	S32S 4C T-max9	M8x26 A4 TCM 86		1.110,00

İÇ KANAL KATERLERİ

KOD	ÜRÜN AÇIKLAMASI	YEDEKLER	UÇ TİPİ	FİYATI
İK032	S16Q 3C T-max4	M4x12 A3 TCM 80	GRP 3mm ISCR	880,00
İK033	S20R 3C T-max4			923,00
İK034	S25S 3C T-max5.5	M6x16 A5 TCM 84		1.008,00

İÇ KANAL KATERLERİ

KOD	ÜRÜN AÇIKLAMASI	YEDEKLER	UÇ TİPİ	FİYATI
İK035	S20R 2C T-max4.5	M4x12 A3 TCM 80	S224 2mm K.HORN	923,00
İK036	S25S 2C T-max6.5	M6x16 A5 TCM 84		1.008,00
İK037	S32S 2C T-max7	M8x26 A4 TCM 86		1.110,00
İK038	S20R 3C T-max4.5	M4x12 A3 TCM 80	S224 3mm K.HORN	923,00
İK039	S25S 3C T-max6.5	M6x16 A5 TCM 84		1.008,00
İK040	S32S 3C T-max7	M8x26 A4 TCM 86		1.110,00
İK041	S20R 4C T-max4.5	M4x12 A3 TCM 80	S224 4mm K.HORN	923,00
İK042	S25S 4C T-max6.5	M6x16 A5 TCM 84		1.008,00
İK043	S32S 4C T-max7	M8x26 A4 TCM 86		1.110,00

İÇ KANAL KATERLERİ

KOD	ÜRÜN AÇIKLAMASI	YEDEKLER	UÇ TİPİ	FİYATI
İK044	S25S 3C T-max8	M6x16 A5 TCM 84	S229 3mm B.HORN	1.008,00
İK045	S32S 3C T-max10	M8x26 A4 TCM 86		1.110,00
İK046	S40U 3C T-max10			1.833,00
İK047	S25S 4C T-max8	M6x16 A5 TCM 84	S229 4mm B.HORN	1.008,00
İK048	S32S 4C T-max10	M8x26 A4 TCM 86		1.110,00
İK049	S40U 4C T-max10			1.833,00
İK050	S25S 5C T-max8	M6x16 A5 TCM 84	S229 5mm B.HORN	1.008,00
İK051	S32S 5C T-max10	M8x26 A4 TCM 86		1.110,00
İK052	S40U 5C T-max10			1.833,00

İÇ KANAL KATERLERİ



KOD	ÜRÜN AÇIKLAMASI	YEDEKLER	UÇ TİPİ	FİYATI
İK053	S16Q 2C T-max4	M4x12 A3 TCM 80	ZT-D 2mm ZCC	880,00
İK054	S20R 2C T-max4.5			923,00
İK055	S25S 2C T-max6	M6x16 A5 TCM 84		1.008,00
İK056	S20R 3C T-max4.5	M4x12 A3 TCM 80	ZT-D 3mm ZCC	923,00
İK057	S25S 3C T-max6	M6x16 A5 TCM 84		1.008,00
İK058	S32S 3C T-max8	M8x26 A4 TCM 86		1.110,00
İK059	S25S 4C T-max6	M6x16 A5 TCM 84	ZT-D 4mm ZCC	1.008,00
İK060	S32S 4C T-max9	M8x26 A4 TCM 86		1.110,00
İK061	S32S 5C T-max9	M8x26 A4 TCM 86	ZT-D 5mm ZCC	1.110,00
İK062	S40U 5C T-max10			1.833,00

İÇ KANAL KATERLERİ



KOD	ÜRÜN AÇIKLAMASI	YEDEKLER	UÇ TİPİ	FİYATI
İK063	S20R 2C T-max4.5	M4x12 A3 TCM 80	N123 2mm SNDV	923,00
İK064	S25S 2C T-max6	M6x16 A5 TCM 84		1.008,00
İK065	S20R 3C T-max9	M4x12 A3 TCM 80	N123 3mm SNDV	923,00
İK066	S25S 3C T-max6	M6x16 A5 TCM 84		1.008,00
İK067	S32S 3C T-max9	M8x26 A4 TCM 86		1.110,00
İK068	S25S 4C T-max6	M6x16 A5 TCM 84	N123 4mm SNDV	1.008,00
İK069	S32S 4C T-max9	M8x26 A4 TCM 86		1.110,00

İÇ KANAL KATERLERİ



KOD	ÜRÜN AÇIKLAMASI	YEDEKLER	UÇ TİPİ	FİYATI
İK070	S18-16Q 2C T-max4.5	M4x12 A3 TCM 80	GDM 2mm KYCR	923,00
İK072	S20-16R 2C T-max4			923,00
İK073	S20R 2C T-max4	M6x16 A5 TCM 84		923,00
İK074	S25S 2C T-max5			1.008,00
İK075	S18-16Q 3C T-max4.5	M4x12 A3 TCM 80	GDM 3mm KYCR	923,00
İK076	S20-16R 3C T-max4			923,00
İK077	S20R 3C T-max4	M6x16 A5 TCM 84		923,00
İK078	S25S 3C T-Max5.5			1.008,00
İK080	S32S 3C T-max9	M8x26 A4 TCM 86	1.110,00	
İK081	S20R 4C T-max5.5	M4x12 A3 TCM 80	GDM 4mm KYCR	1.089,00
İK082	S25S 4C T-max6	M6x16 A5 TCM 84		1.008,00
İK083	S25S 4C T-max12			1.008,00
İK084	S32S 4C T-max9	M8x26 A4 TCM 86		1.110,00
İK085	S32S 4C T-max12			1.110,00
İK086	S40U 4C T-max10			1.833,00

İÇ KANAL KATERLERİ



KOD	ÜRÜN AÇIKLAMASI	YEDEKLER	UÇ TİPİ	FİYATI
İK087	S20R 2C T-max4	M4x12 A3 TCM 80	VGD 2mm VARG	923,00
İK088	S25S 2C T-max5.5	M6x16 A5 TCM 84		1.008,00
İK089	S32S 2C T-max9	M8x26 A4 TCM 86		1.110,00
İK090	S20R 3C T-max4	M4x12 A3 TCM 80	VGD 3mm VARG	923,00
İK091	S25S 3C T-max5.5	M6x16 A5 TCM 84		1.008,00
İK092	S32S 3C T-max9	M8x26 A4 TCM 86		1.110,00
İK094	S25S 4C T-max5.5	M6x16 A5 TCM 84	VGD 4mm VARG	1.008,00
İK095	S32S 4C T-max9	M8x26 A4 TCM 86		1.110,00

B.ST HRN



KOD	ÜRÜN AÇIKLAMASI	YEDEKLER	UÇ TİPİ	FİYATI
B.ST01	A05.0016.07.B.ST	M4x8 SETSKUR	A05.0016.07.B.ST	1.194,00
B.ST02	A07.0020.07.B.ST		A07.0020.07.B.ST	1.194,00
B.ST03	A08.0020.09.B.ST		A08.0020.09.B.ST	1.194,00
B.ST04	A09.0025.07.B.ST		A09.0025.07.B.ST	1.194,00

MİNİ KANAL KATERİ



KOD	ÜRÜN AÇIKLAMASI	YEDEKLER	UÇ TİPİ	FİYATI
MİNİ01	HD12-06- L1-18 -L100	M2.5x7x3.5 TCM 18	HD-1206 R	1.023,00
MİNİ02	HD12-07- L1-18 -L100	M3x10x4.2 TCM 30	HD-1207 R	1.023,00
MİNİ03	HD12-08- L1-18 -L100	M3.5x10x5.3 TCM 34	HD-1208 R	1.023,00
MİNİ04	HD12-09- L1-18 -L100		HD-1209 R	1.023,00
MİNİ05	HD12-11- L1-18 -L100	M4.5x12x6.5 TCM 87	HD-1211 R	1.023,00

HELİS TARAMA BAŞLIKLARI



KOD	ÜRÜN AÇIKLAMASI	YEDEKLER	UÇ TİPİ	FİYATI
HFM01	050x3x4-22	M3.5x8x5.3 TCM 33	APKT 1604 İSO	7.230,00
HFM02	063x4x4-22			8.080,00
HFM03	080x5x5-27			8.930,00



KOD	ÜRÜN AÇIKLAMASI	YEDEKLER	UÇ TİPİ	FİYATI
HFM05	050x4x4-22	M4x11x5.3	LNKT 1205	7.963,00
HFM06	050x4x4-27	TCM 42	ZCC	7.963,00

HELİS FREZELER



KOD	ÜRÜN AÇIKLAMASI	YEDEKLER	UÇ TİPİ	FİYATI
HFM10	20xZ2x3 W20 L110 HELİS FREZE	M2.5x7x3.5 TCM 18	APKT 1003 İSO	3.404,00
HFM11	25xZ2x4 W25 L120 HELİS FREZE			4.212,00
HFM12	32xZ3x5 W32 L120 HELİS FREZE			5.529,00
HFM13	40xZ3x6 W32 L130 HELİS FREZE			5.955,00



KOD	ÜRÜN AÇIKLAMASI	YEDEKLER	UÇ TİPİ	FİYATI
HFM07	80 x 9-27 55°	M3.5x10x5.3 TCM 34	DCMT 11T3 İSO	7.658,00
HFM08	80 x 9-27 60°			7.658,00
HFM09	50 x 4-22 60°			5.318,00

DİSK FREZELER



KOD	ÜRÜN AÇIKLAMASI	YEDEKLER	UÇ TİPİ	FİYATI
DFM02	080x08xZ10 -27	M2.5x6x3.5 TCM 16	CCMT 0602 İSO	3.063,00
DFM04	100x08xZ12 -32			3.488,00
DFM06	125x08xZ14 -40			4.252,00
DFM08	160x08xZ16 -40			5.102,00
DFM10	080x10xZ10 -27			3.063,00
DFM12	100x10xZ12 -32			3.488,00
DFM14	125x10xZ14 -40			4.252,00
DFM16	160x10xZ16 -40			5.102,00
DFM18	080x12xZ08 -27	M3.5x8x5.3 TCM 33	CCMT 09T3 İSO	3.063,00
DFM20	100x12xZ10 -32			3.488,00
DFM22	125x12xZ12 -40			4.252,00
DFM24	160x12xZ14 -40			5.102,00
DFM26	080x14xZ08 -27			3.063,00
DFM28	100x14xZ10 -32			3.488,00
DFM30	125x14xZ12 -40			4.252,00
DFM32	160x14xZ14 -40			5.102,00
DFM34	080x16xZ06 -27	M5x12x7 TCM 46	CCMT 1204 İSO	3.063,00
DFM36	100x16xZ08 -32			3.488,00
DFM38	125x16xZ10 -40			4.252,00
DFM40	160x16xZ12 -40			5.102,00

HAVŞA FREZELER



KOD	ÜRÜN AÇIKLAMASI	YEDEKLER	UÇ TİPİ	FİYATI
HM02	04-15-Z01 W16 L100 45°	M2.5x7x3.5 TCM 18	TCMT 1102 İSO	809,00
HM04	14-25-Z02 W25 L100 45°			809,00
HM06	16-30-Z03 W12 L100 45°			809,00
HM08	21-35-Z03 W12 L100 45°			894,00
HM10	05-23-Z01 W16 L100 45°	M3.5x8x5.3 TCM 33	TCMT 16T3 İSO	829,00
HM12	10-31-Z02 W16 L100 45°			829,00
HM14	14-35-Z02 W20 L100 45°			829,00
HM16	22-43-Z03 W25 L100 45°			914,00
HM18	30-50-Z03 W25 L100 45°		1.322,00	
HM20	06-20-Z01 W16 L100 60°		TCMT 16T3 İSO	745,00
HM22	20-35-Z02 W16 L100 60°			809,00
HM24	24-40-Z02 W25 L100 60°			1.322,00

T- FREZELER



KOD	ÜRÜN AÇIKLAMASI	YEDEKLER	UÇ TİPİ	FİYATI
TFM02	17-Z02-09 W16 L85 T FREZE	M2.5x7x3.5 TCM 18	CCMT 0602 İSO	1.363,00
TFM04	20-Z02-09 W16 L85 T FREZE			1.363,00
TFM06	21-Z02-09 W16 L85 T FREZE			1.363,00
TFM08	24-Z02-10 W20 L100 T FREZE			1.449,00
TFM10	25-Z02-11 W25 L100 T FREZE			1.449,00
TFM12	25-Z02-12 W25 L100 T FREZE			1.449,00
TFM14	32-Z04-08 W25 L100 T FREZE			1.872,00
TFM16	32-Z04-10 W25 L100 T FREZE			1.872,00
TFM18	63-Z08-08 W32 L125 T FREZE			3.189,00

T- FREZELER

KOD	ÜRÜN AÇIKLAMASI	YEDEKLER	UÇ TİPİ	FİYATI
TFM20	30-Z02-12 W25 L100 T FREZE	M3.5x8x5.3 TCM 33	CCMT 09T3 İSO	1.872,00
TFM22	32-Z02-12 W25 L100 T FREZE			1.872,00
TFM24	32-Z02-14 W25 L100 T FREZE			1.872,00
TFM26	40-Z04-12 W32 L120 T FREZE			2.002,00
TFM28	40-Z04-16 W32 L120 T FREZE			2.002,00
TFM30	40-Z04-18 W32 L120 T FREZE			2.127,00
TFM32	50-Z04-12 W32 L120 T FREZE			2.512,00
TFM34	50-Z04-16 W32 L120 T FREZE			2.550,00

SAPLI TARAMALAR

KOD	ÜRÜN AÇIKLAMASI	YEDEKLER	UÇ TİPİ	FİYATI
ST001	12-Z1-W12 L120	M2.5x6x3.5 TCM 16	APKT 1003 İSO	809,00
ST002	14-Z1-W12 L120			850,00
ST003	16-Z2-W16 L100			850,00
ST004	16-Z2-W16 L120			978,00
ST005	16-Z2-W16 L150			1.105,00
ST006	16-Z2-W16 L200			1.322,00
ST007	16-Z2-W16 L250			1.403,00
ST007-1	17-Z2-W16 L150			1.233,00
ST008	18-Z2-W16 L100			850,00
ST009	18-Z2-W16 L120			937,00
ST010	18-Z2-W16 L150			1.233,00
ST011	18-Z2-W16 L200			1.403,00
ST012	18-Z2-W16 L250	1.492,00		
ST013	20-Z3-W20 L100	M2.5x7x3.5 TCM 18	APKT 1003 İSO	978,00
ST014	20-Z3-W20 L120			1.064,00
ST015	20-Z3-W20 L150			1.363,00
ST016	20-Z3-W20 L200			1.618,00
ST017	20-Z3-W20 L250			1.787,00
ST017-1	21-Z3-W20 L150			1.363,00
ST017-2	21-Z3-W20 L200			1.700,00
ST018	22-Z3-W20 L100			1.023,00
ST019	22-Z3-W20 L120			1.064,00
ST020	22-Z3-W20 L150			1.363,00
ST021	22-Z3-W20 L200			1.700,00
ST022	22-Z3-W20 L250			1.917,00
ST023	25-Z3-W25 L100			1.153,00
ST024	25-Z3-W25 L120			1.233,00
ST025	25-Z3-W25 L150			1.492,00
ST026	25-Z3-W25 L200			1.787,00
ST028	25-Z3-W25 L250			1.958,00

SAPLI TARAMALAR



KOD	ÜRÜN AÇIKLAMASI	YEDEKLER	UÇ TİPİ	FİYATI
ST029	26-Z3-W25 L150	M2.5x7x3.5 TCM 18	APKT 1003 İSO	1.492,00
ST030	26-Z3-W25 L200			1.787,00
ST031	26-Z3-W25 L250			1.958,00
ST032	28-Z4-W25 L150			1.492,00
ST033	30-Z4-W25 L100			1.233,00
ST034	30-Z4-W25 L120			1.403,00
ST035	30-Z4-W25 L150			1.575,00
ST036	30-Z4-W25 L200			1.917,00
ST038	32-Z4-W32 L150			1.660,00
ST039	32-Z4-W32 L200			1.787,00
ST040	35-Z4-W25 L100			1.363,00
ST041	35-Z4-W25 L120			1.449,00
ST042	35-Z4-W25 L150			1.575,00
ST043	35-Z4-W25 L200			1.917,00
ST044	40-Z5-W25 L100			1.449,00
ST045	40-Z5-W25 L120			1.492,00
ST046	40-Z5-W25 L150	1.618,00		
ST047	40-Z5-W25 L200	2.127,00		

SAPLI TARAMALAR



KOD	ÜRÜN AÇIKLAMASI	YEDEKLER	UÇ TİPİ	FİYATI
ST048	25-Z2-W25 L120	M3.5x8x5.3 TCM 33	APKT 1604 İSO	1.064,00
ST049	25-Z2-W25 L150			1.403,00
ST050	25-Z2-W25 L200			1.618,00
ST051	25-Z2-W25 L250			2.085,00
ST052	25-Z2-W25 L300			2.382,00
ST053	30-Z3-W25 L120	M3.5x10x5.3 TCM 34		1.105,00
ST054	30-Z3-W25 L150			1.449,00
ST055	30-Z3-W25 L200			1.787,00
ST056	30-Z3-W25 L250			2.213,00
ST057	30-Z3-W25 L300			2.382,00
ST058	32-Z3-W25 L120			1.153,00
ST059	32-Z3-W25 L150			1.492,00
ST060	32-Z3-W32 L200			1.787,00
ST061	32-Z3-W32 L250			2.297,00
ST062	32-Z3-W32 L300			2.382,00
ST063	32-Z3-W32 L350			2.680,00
ST064	35-Z3-W25 L120	1.233,00		
ST065	35-Z3-W32 L150	1.492,00		
ST067	35-Z3-W32 L250	2.213,00		
ST068	35-Z3-W32 L300	2.382,00		
ST069	35-Z3-W32 L350	2.640,00		

SAPLI TARAMALAR

KOD	ÜRÜN AÇIKLAMASI	YEDEKLER	UÇ TİPİ	FİYATI
ST070	40-Z4-W25 L120	M3.5x10x5.3 TCM 34	APKT 1604 İSO	1.363,00
ST071	40-Z4-W32 L150			1.618,00
ST071-1	40-Z4-W25 L150			1.660,00
ST072	40-Z4-W32 L200			2.127,00
ST073	40-Z4-W32 L250			2.340,00
ST074	40-Z4-W32 L300			2.512,00
ST075	40-Z4-W32 L350			2.680,00

SAPLI TARAMALAR

KOD	ÜRÜN AÇIKLAMASI	YEDEKLER	UÇ TİPİ	FİYATI
ST076	35-Z2-W25 L100	M6x0,75	TPKN 1603 İSO	1.130,00
ST077	40-Z3-W25 L100			1.219,00
ST078	50-Z3-W25 L100			1.349,00

SAPLI TARAMALAR

KOD	ÜRÜN AÇIKLAMASI	YEDEKLER	UÇ TİPİ	FİYATI
ST080	32-Z2-W32 L250	M5x12x7 TCM 46	VCGT 2205 İSO	1.787,00

SAPLI TARAMALAR

KOD	ÜRÜN AÇIKLAMASI	YEDEKLER	UÇ TİPİ	FİYATI
ST082	20-Z2-W20 L150	M3.5x8x5.3 TCM 33	RPMW 1003 İSO	1.363,00
ST083	25-Z2-W25 L150			1.449,00

SAPLI TARAMALAR

KOD	ÜRÜN AÇIKLAMASI	YEDEKLER	UÇ TİPİ	FİYATI
ST090	10-Z2-W10 L100	M2x5x2.7 TCM 06	RDMW 0501 İSO	937,00
ST092	12-Z2-W12 L100			937,00
ST093-1	16-Z2-W16 L120	M3x6 TCM 24	RDMW 0803 İSO	937,00
ST093-2	16-Z2-W16 L150			1.233,00
ST094	20-Z2-W20 L120		RDMW 1003 İSO	1.064,00
ST095	20-Z2-W20 L150			1.233,00
ST096	20-Z2-W20 L200	1.492,00		
ST097	25-Z2-W25 L150	M3.5x8x5.3 TCM 33	RDMW 1003 İSO	1.363,00
ST098	25-Z2-W25 L200			1.532,00
ST099	32-Z3-W32 L150			1.492,00
ST100	32-Z3-W32 L200			1.872,00
ST101	40-Z4-W32 L150			1.787,00
ST102	40-Z4-W32 L250			1.958,00

SAPLI TARAMALAR



KOD	ÜRÜN AÇIKLAMASI	YEDEKLER	UÇ TİPİ	FİYATI
ST103	25-Z2-W25 L150	M3.5x8x5.3 TCM 33	RDMW 1204 İSO	1.449,00
ST105	32-Z3-W25 L150			1.492,00
ST106	32-Z3-W25 L200			1.787,00
ST107	40-Z4-W25 L150			1.787,00
ST108	40-Z4-W32 L150			1.787,00

SAPLI TARAMALAR



KOD	ÜRÜN AÇIKLAMASI	YEDEKLER	UÇ TİPİ	FİYATI
ST110	25-Z2-W25 L150	M3x8x4.2 TCM 29	WDKT 08 İSO	1.403,00
ST111	30-Z2-W32 L150			1.618,00
ST112	32-Z2-W32 L150			1.660,00

SAPLI TARAMALAR



KOD	ÜRÜN AÇIKLAMASI	YEDEKLER	UÇ TİPİ	FİYATI
ST116	25-Z2-W25 L160	M4x9x5.4 TCM 40	SOMT 1004 KYCR	1.782,00
ST117	26-Z2-W25 L160			1.926,00
ST118	33-Z3-W32 L160			2.091,00

SAPLI TARAMALAR



KOD	ÜRÜN AÇIKLAMASI	YEDEKLER	UÇ TİPİ	FİYATI
ST119	10-Z1-W10 L100	M2x5x2.7 TCM 06	BDMT 0703 KYCR	1.519,00
ST120	11-Z2-W10 L120			1.519,00
ST121	12-Z2-W11 L120			1.519,00
ST122	12-Z2-W12 L120			1.519,00
ST123	14-Z3-W12 L120			1.537,00
ST124	16-Z3-W16 L120			1.588,00
ST125	16-Z2-W15 L160	M2.5x6x3.5 TCM 16	BDMT 11T3 KYCR	1.417,00
ST126	16-Z2-W16 L160			1.417,00
ST127	16-Z2-W16 L180			1.458,00
ST128	17-Z2-W16 L160			1.417,00
ST129	17-Z2-W16 L200			1.550,00
ST130	18-Z2-W16 L160	M2.5x7x3.5 TCM 18	BDMT 11T3 KYCR	1.550,00
ST131	20-Z3-W20 L120			1.458,00
ST132	20-Z3-W20 L160			1.550,00
ST133	20-Z3-W20 L180			1.592,00
ST134	21-Z3-W20 L160	M2.5x7x3.5 TCM 18	BDMT 11T3 KYCR	1.550,00
ST135	21-Z3-W20 L180			1.592,00
ST136	21-Z3-W20 L200			1.682,00
ST137	25-Z3-W25 L160			1.726,00
ST138	25-Z3-W25 L200			1.760,00

SAPLI TARAMALAR

KOD	ÜRÜN AÇIKLAMASI	YEDEKLER	UÇ TİPİ	FİYATI
ST139	26-Z4-W25 L160	M2.5x7x3.5 TCM 18	BDMT 11T3 KYCR	1.726,00
ST140	26-Z3-W25 L200			1.901,00
ST141	32-Z4-W32 L200			2.301,00
ST143	33-Z4-W32 L150			2.035,00
ST144	33-Z4-W32 L200			2.301,00
ST145	25-Z2-W25 L160	M4x9x5.4 TCM 40	BDMT 1704 KYCR	1.609,00
ST147	32-Z3-W32 L200			1.948,00

SAPLI TARAMALAR

KOD	ÜRÜN AÇIKLAMASI	YEDEKLER	UÇ TİPİ	FİYATI
ST151	17-Z2-W16 L160	M2.5x6x3.5 TCM 16	APKT 1003 KYCR	1.458,00
ST152	21-Z3-W20 L160	M2.5x7x3.5 TCM 18		1.550,00
ST153	25-Z3-W25 L160			1.638,00

SAPLI TARAMALAR

KOD	ÜRÜN AÇIKLAMASI	YEDEKLER	UÇ TİPİ	FİYATI
ST156	16-Z2-W16 L100	M3x8x4.2 TCM 29	LOMU 1004 KYCR	1.537,00
ST157	16-Z2-W16 L150			1.679,00
ST158	16-Z2-W16 L160			1.729,00
ST159	17-Z2-W16 L160			1.729,00
ST160	20-Z3-W20 L110			1.822,00
ST161	20-Z3-W20 L160			1.866,00
ST162	21-Z3-W20 L160			1.917,00
ST163	21-Z3-W20 L200			2.069,00
ST165-1	25-Z3-W25 L160			2.241,00
ST166	25-Z3-W25 L200			2.289,00

SAPLI TARAMALAR

KOD	ÜRÜN AÇIKLAMASI	YEDEKLER	UÇ TİPİ	FİYATI
ST175	16-Z2-W15 L160	M3x8x4 TCM 28	LOGU 0303 KYCR	1.528,00
ST176	16-Z2-W16 L160			1.528,00
ST177	16-Z2-W16 L200			1.652,00
ST178	17-Z2-W16 L160			1.528,00
ST179	17-Z2-W16 L200			1.652,00
ST180	18-Z2-W16 L160			1.571,00
ST182	20-Z3-W20 L110			1.528,00
ST183	20-Z3-W20 L130			1.528,00
ST184	20-Z3-W20 L160			1.652,00
ST185	20-Z3-W20 L200			1.761,00
ST187	21-Z3-W20 L160			1.652,00
ST187-1	21-Z3-W20 L200			1.848,00
ST188	22-Z3-W20 L160	1.652,00		

SAPLI TARAMALAR



KOD	ÜRÜN AÇIKLAMASI	YEDEKLER	UÇ TİPİ	FİYATI
ST191	25-Z4-W25 L160	M3x8x4 TCM 28	LOGU 0303 KYCR	1.985,00
ST192	25-Z4-W25 L180			2.064,00
ST193	26-Z4-W25 L160			2.024,00
ST194-1	26-Z4-W25 L200			2.187,00
ST194-2	26-Z4-W25 L250			2.355,00
ST195	26-Z4-W25 L300			2.765,00
ST196	28-Z5-W25 L160			2.064,00
ST198	28-Z5-W25 L200			2.187,00
ST199	32-Z5-W32 L160			2.104,00
ST200	32-Z5-W32 L200			2.314,00
ST201	33-Z5-W32 L160			2.104,00

SAPLI TARAMALAR



KOD	ÜRÜN AÇIKLAMASI	YEDEKLER	UÇ TİPİ	FİYATI
ST202	16-Z2-W16 L120	M2.5x7x3.5 TCM 18	LNMT 0804 ISCR	1.618,00
ST203	18-Z2-W16 L120			1.660,00
ST204	20-Z3-W20 L120			1.748,00
ST205	25-Z4-W25 L150			1.958,00
ST207	30-Z4-W25 L150			1.934,00
ST209	32-Z4-W32 L200			2.170,00

SAPLI TARAMALAR



KOD	ÜRÜN AÇIKLAMASI	YEDEKLER	UÇ TİPİ	FİYATI
ST210	16-Z2-W16 L150	M3x8x4.2 TCM 29	ANKX 0904 ISCR	1.403,00
ST211	20-Z3-W20 L150			1.449,00
ST212	25-Z3-W25 L150			1.575,00
ST214	30-Z3-W25 L150	M4x11x5.3 TCM 42	ANKX 1205 ISCR	1.449,00
ST215	30-Z3-W30 L110			1.449,00
ST216	30-Z3-W25 L120			1.403,00
ST217	30-Z3-W25 L200			1.449,00
ST219	35-Z3-W32 L120			1.449,00
ST220	35-Z3-W32 L150			1.532,00

SAPLI TARAMALAR



KOD	ÜRÜN AÇIKLAMASI	YEDEKLER	UÇ TİPİ	FİYATI
ST221	16-Z2-W16 L150	M2.5x7x3.5 TCM 18	TCKT 0703	1.449,00
ST222	20-Z3-W20 L150		ISCR	1.532,00

SAPLI TARAMALAR



KOD	ÜRÜN AÇIKLAMASI	YEDEKLER	UÇ TİPİ	FİYATI
ST223	25-Z3-W25 L120	M3x8x4.2 TCM 29	TPKT 1003 ISCR	1.917,00
ST224	25-Z3-W25 L150			2.044,00
ST226	32-Z4-W32 L150			2.340,00

SAPLI TARAMALAR

KOD	ÜRÜN AÇIKLAMASI	YEDEKLER	UÇ TİPİ	FİYATI
ST231	25-Z2-W25 L150	M4x11x5.3 TCM 42	ADKT 1505 ISCR	1.403,00
ST232	32-Z3-W32 L150			1.532,00
ST233	40-Z4-W32 L150			1.618,00

SAPLI TARAMALAR

KOD	ÜRÜN AÇIKLAMASI	YEDEKLER	UÇ TİPİ	FİYATI
ST235	16-Z2-W16 L120	M2.5x6x3.5 TCM 16	APKT 0903 WLTR	1.153,00
ST236	16-Z2-W16 L150			1.233,00
ST237	16-Z2-W16 L200			1.363,00
ST238	20-Z3-W20 L120	M2.5x7x3.5 TCM 18		1.275,00
ST240	20-Z3-W20 L200			1.618,00

SAPLI TARAMALAR

KOD	ÜRÜN AÇIKLAMASI	YEDEKLER	UÇ TİPİ	FİYATI
ST241	16-Z2-W16 L150	M2.5x6x3.5 TCM 16	ADMT 0803 WLTR	1.153,00
ST242	20-Z3-W20 L150	M2.5x7x3.5 TCM 18		1.363,00
ST243	20-Z3-W16 L200			1.575,00
ST244	20-Z3-W20 L200			1.575,00
ST245	26-Z3-W25 L150			1.575,00
ST246	26-Z3-W25 L200	1.700,00		
ST248	20-Z3-W20 L120	M2.5x7x3.5 TCM 18	ADMT 10T3 WLTR	1.363,00
ST249	25-Z3-W25 L120			1.449,00
ST250	20-Z2-W20 L120	M3x8x4.2 TCM 29	ADMT 1204 WLTR	1.338,00
ST251	20-Z2-W20 L150			1.365,00
ST252	25-Z3-W25 L120			1.575,00
ST253	25-Z3-W25 L150			1.618,00
ST254	30-Z3-W25 L120			1.700,00
ST255	30-Z3-W25 L150			1.787,00
ST256	32-Z4-W32 L150			1.829,00
ST257	40-Z4-W32 L120			1.917,00
ST258	40-Z4-W32 L150			2.002,00

SAPLI TARAMALAR

KOD	ÜRÜN AÇIKLAMASI	YEDEKLER	UÇ TİPİ	FİYATI
ST259	20-Z3-W20 L120	M3x10x4.2 TCM 30	LNHU 0904 WLTR	1.275,00
ST260	20-Z3-W20 L150			1.403,00
ST261	25-Z4-W25 L120			1.492,00
ST262	25-Z4-W25 L150			1.618,00
ST263	32-Z5-W32 L120			1.787,00
ST264	30-Z3-W25 L150	M4x9x5.4 TCM 40	LNHU 1306 WLTR	1.618,00
ST266	40-Z4-W32 L150			1.872,00
ST267	40-Z4-W40 L200			2.255,00

SAPLI TARAMALAR



KOD	ÜRÜN AÇIKLAMASI	YEDEKLER	UÇ TİPİ	FİYATI
ST268	16-Z2-W16 L130	M3x8x4.2 TCM 29	LNMX 0603 KRLY	1.492,00
ST269	16-Z2-W16 L150			1.492,00
ST271	17-Z2-W16 L200			1.700,00
ST272	20-Z3-W20 L150			1.660,00
ST273	20-Z3-W20 L250			1.872,00
ST274	21-Z3-W20 L150			1.660,00
ST275	25-Z4-W25 L150			1.829,00
ST276	25-Z4-W25 L250			2.044,00
ST277	32-Z5-W32 L150			2.127,00
ST278	40-Z6-W32 L150			2.297,00
ST280	16-Z1-W16 L090	M3x8x4.2 TCM 29	LNMX 1006 KRLY	937,00
ST282	18-Z2-W16 L120			1.170,00
ST283	20-Z2-W20 L100			1.275,00
ST285	20-Z2-W20 L150			1.322,00
ST286	25-Z3-W25 L115			1.575,00
ST287	25-Z3-W25 L150			1.618,00
ST287-1	26-Z3-W25 L200			1.829,00
ST289	32-Z4-W32 L125			1.660,00
ST290	32-Z4-W32 L200			1.853,00
ST291	40-Z4-W32 L130			1.829,00
ST292	40-Z5-W32 L130	1.999,00		

SAPLI TARAMALAR



KOD	ÜRÜN AÇIKLAMASI	YEDEKLER	UÇ TİPİ	FİYATI
ST294	16-Z2-W16 L150	M2.5x7x3.5 TCM 18	WNMX 0603 KRLY	1.403,00
ST295	17-Z2-W16 L150			1.403,00
ST296	20-Z3-W20 L150			1.532,00
ST297	21-Z3-W20 L150			1.532,00
ST298	25-Z2-W25 L150	M3x8x4.2 TCM 29	WNMX 09T3 KRLY	1.532,00
ST299	32-Z3-W32 L150			1.829,00

SAPLI TARAMALAR



KOD	ÜRÜN AÇIKLAMASI	YEDEKLER	UÇ TİPİ	FİYATI
ST300	16-Z2-W16 L120	M2.5x6x3.5 TCM 16	APMT 11T3 KRLY	937,00
ST301	16-Z2-W16 L150			1.233,00
ST302	16-Z2-W16 L200			1.403,00
ST303	17-Z2-W16 L120			978,00
ST304	17-Z2-W16 L150			1.275,00
ST304-1	18-Z2-W16 L120			978,00

SAPLI TARAMALAR

KOD	ÜRÜN AÇIKLAMASI	YEDEKLER	UÇ TİPİ	FİYATI
ST305	20-Z3-W20 L120	M2.5x7x3.5 TCM 18	APMT 11T3 KRLY	1.213,00
ST306	20-Z3-W20 L150			1.363,00
ST307	20-Z3-W20 L200			1.492,00
ST308	21-Z3-W20 L120			1.233,00
ST309	21-Z3-W20 L150			1.403,00
ST310	21-Z3-W20 L200			1.532,00
ST311	22-Z3-W20 L120			1.233,00
ST312	22-Z3-W20 L150			1.403,00
ST313	25-Z3-W25 L150			1.492,00

SAPLI TARAMALAR

KOD	ÜRÜN AÇIKLAMASI	YEDEKLER	UÇ TİPİ	FİYATI
ST314	18-Z2-W20 L150	M3x8x4.2 TCM 29	XNKT 0604 KRLY	1.618,00
ST315	20-Z2-W20 L150			1.660,00
ST315-1	21-Z2-W20 L150			1.814,00
ST316	21-Z2-W20 L200			2.213,00
ST317	22-Z2-W20 L150			1.787,00
ST318	25-Z3-W25 L150			1.958,00
ST319	25-Z3-W25 L200			2.297,00
ST320	26-Z3-W25 L150			2.002,00
ST321	26-Z3-W25 L200			2.340,00
ST322	32-Z4-W32 L150			2.382,00
ST323	32-Z3-W32 L150	M4x9x5.4 TCM 40	XNKT 0805 KRLY	2.213,00
ST324	32-Z3-W32 L200			2.467,00
ST326	40-Z4-W32 L200			2.597,00
ST328	42-Z4-W32 L150			2.682,00

SAPLI TARAMALAR

KOD	ÜRÜN AÇIKLAMASI	YEDEKLER	UÇ TİPİ	FİYATI
ST329	16-Z2-W16 L100	M2.5x7x3.5 TCM 18	R390 11T3 SNDV	937,00
ST330	16-Z2-W16 L150			1.194,00
ST331	20-Z3-W20 L100			1.057,00
ST332	20-Z3-W20 L150			1.275,00
ST333	25-Z3-W25 L100	M3.5x10x5.3 TCM 34	R390 1704 SNDV	1.122,00
ST334	25-Z3-W25 L150			1.363,00
ST335	25-Z2-W25 L150			1.492,00
ST336	32-Z3-W32 L150			1.748,00
ST337	40-Z4-W25 L150			1.917,00

SAPLI TARAMALAR



KOD	ÜRÜN AÇIKLAMASI	YEDEKLER	UÇ TİPİ	FİYATI
ST338	10-Z2-W09 L130	M1.8x4.2x2.4 TCM 02	APKT 0702 ZCC	1.281,00
ST339	10-Z2-W10 L130			1.281,00
ST340	12-Z2-W10 L130			1.326,00
ST341	12-Z2-W12 L130			1.326,00
ST342	12-Z2-W10 L150			1.391,00
ST343	12-Z2-W12 L150			1.391,00
ST344	14-Z3-W12 L130			1.458,00
ST345	14-Z3-W12 L150			1.514,00
ST346	16-Z2-W16 L100	M2.5x7x3.5 TCM 18	APKT 11T3 ZCC	1.198,00
ST347	16-Z2-W16 L160			1.326,00
ST348	16-Z2-W16 L200			1.458,00
ST349	17-Z2-W16 L160			1.326,00
ST350	17-Z2-W16 L200			1.417,00
ST351	17-Z2-W16 L250			1.592,00
ST352	18-Z2-W16 L160			1.326,00
ST353	20-Z3-W20 L120			1.281,00
ST354	20-Z3-W20 L160			1.417,00
ST355	20-Z3-W20 L200			1.639,00
ST356	21-Z3-W20 L160			1.458,00
ST357	21-Z3-W20 L200			1.550,00
ST358	21-Z3-W20 L250			1.726,00
ST359	25-Z3-W25 L120			1.550,00
ST360	25-Z3-W25 L160			1.682,00
ST361	25-Z3-W25 L200	1.768,00		
ST362	26-Z3-W25 L160	1.726,00		
ST363	26-Z3-W25 L200	1.726,00		
ST364	26-Z3-W25 L250	1.901,00		
ST365	32-Z4-W32 L200	1.946,00		
ST366	25-Z2-W25 L170	M4x9x5.4 TCM 40	APKT 1604 ZCC	1.506,00
ST367	26-Z2-W25 L200			1.682,00
ST368	26-Z2-W25 L250			1.901,00
ST369	32-Z3-W32 L170			1.682,00
ST370	32-Z3-W32 L200			1.857,00
ST371	33-Z3-W32 L250			2.035,00
ST372	33-Z3-W32 L300			2.211,00
ST373	33-Z3-W32 L350	2.564,00		
ST374	33-Z3-W32 L400	3.227,00		

SAPLI TARAMALAR

KOD	ÜRÜN AÇIKLAMASI	YEDEKLER	UÇ TİPİ	FİYATI
ST375	25-Z2-W25 L150	M3x8x4.2 TCM 29	ANGX 1105 ZCC	1.550,00
ST376	32-Z3-W32 L150			1.726,00
ST377	40-Z4-W32 L150			1.901,00

SAPLI TARAMALAR

KOD	ÜRÜN AÇIKLAMASI	YEDEKLER	UÇ TİPİ	FİYATI
ST378	20-Z2-W20 L160	M3x8x4 TCM 28	LNKT 0804 ZCC	1.506,00
ST379	25-Z3-W25 L160			1.682,00
ST380	32-Z4-W32 L160			1.768,00



SAPLI TARAMALAR

KOD	ÜRÜN AÇIKLAMASI	YEDEKLER	UÇ TİPİ	FİYATI
ST381	25-Z2-W25 L160	M3x8x4.2 TCM 29	WNHU 0604 ZCC	1.506,00
ST382	26-Z2-W25 L200			1.682,00
ST383	32-Z3-W32 L160			1.726,00

SAPLI TARAMALAR

KOD	ÜRÜN AÇIKLAMASI	YEDEKLER	UÇ TİPİ	FİYATI
ST386	16-Z2-W16 L150	M2.2x5x3 TCM 10	SDMT 06T2 ZCC	1.458,00
ST387	17-Z2-W16 L160			1.458,00
ST388	20-Z3-W20 L150			1.550,00
ST389	21-Z3-W20 L200			1.726,00



KOD	ÜRÜN AÇIKLAMASI	YEDEKLER	UÇ TİPİ	FİYATI		
ST396	22-Z2-W20 L170	 M3.5x8x4.8 TCM 32	 M3.5x10x5.3 TCM 34	1.550,00		
ST399	25-Z2-W25 L160			1.550,00		
ST400	25-Z2-W25 L200			1.726,00		
ST401	26-Z2-W25 L200			1.726,00		
ST403	32-Z3-W25 L150			 KEP 12	SDMT 09T3 ZCC	1.857,00
ST404	32-Z3-W32 L150					1.857,00
ST405	32-Z3-W32 L160					1.857,00
ST407	32-Z3-W32 L200			1.946,00		
ST408	33-Z3-W32 L160			1.857,00		
ST409	33-Z3-W32 L200			1.946,00		
ST410	42-Z4-W32 L160	2.211,00				

SAPLI TARAMALAR



KOD	ÜRÜN AÇIKLAMASI	YEDEKLER	UÇ TİPİ	FİYATI	
ST413	16-Z2-W16 L100	M2.5x6x3.5 TCM 16	XOMX 0903 SCO	1.023,00	
ST414	16-Z2-W16 L130			1.153,00	
ST415	16-Z2-W16 L150			1.233,00	
ST417	20-Z3-W20 L120	M2.5x7x3.5 TCM 18		1.233,00	
ST418	20-Z3-W20 L150			1.275,00	
ST419	20-Z3-W20 L200			1.575,00	
ST420	25-Z3-W25 L150			1.492,00	
ST421	16-Z1-W16 L120	M3.5x8x4.8 TCM 32		XOMX 1204 SCO	1.023,00
ST422	16-Z1-W16 L150				1.105,00
ST423	20-Z2-W20 L100				1.064,00
ST424	20-Z2-W20 L120		1.105,00		
ST425	20-Z2-W20 L150		1.275,00		
ST426	20-Z2-W20 L200		1.492,00		
ST427	22-Z2-W20 L120		1.322,00		
ST428	25-Z3-W25 L100		1.322,00		
ST429	25-Z3-W25 L120		1.403,00		
ST430	25-Z3-W25 L150		1.492,00		
ST431	25-Z3-W25 L200	1.660,00			
ST432	32-Z4-W25 L150	1.618,00			
ST433	32-Z4-W25 L200	1.917,00			

SAPLI TARAMALAR



KOD	ÜRÜN AÇIKLAMASI	YEDEKLER	UÇ TİPİ	FİYATI
ST434	18-Z2-W16 L150	M2.5x7x3.5 TCM 18	XNEX 0403 SCO	1.748,00
ST435	18-Z2-W16 L200			1.787,00
ST436	20-Z3-W20 L150			1.872,00
ST437	21-Z3-W20 L150			1.917,00
ST438	21-Z3-W20 L200			2.002,00
ST439	25-Z4-W25 L150			2.044,00
ST440	25-Z4-W25 L200			2.213,00
ST441	26-Z4-W25 L150			2.085,00
ST442	26-Z4-W25 L200			2.213,00
ST443	32-Z5-W32 L150			2.127,00
ST444	32-Z5-W32 L200	2.382,00		

SAPLI TARAMALAR



KOD	ÜRÜN AÇIKLAMASI	YEDEKLER	UÇ TİPİ	FİYATI
ST476	16-Z2-W16 L150	M2.5x6x3.5	TOMT 0603	1.748,00
ST478	20-Z3-W20 L150	TCM 16	TNGLY	1.872,00

SAPLI TARAMALAR

KOD	ÜRÜN AÇIKLAMASI	YEDEKLER	UÇ TİPİ	FİYATI
ST447	16-Z2-W16 L160	M2.5x7x3.5 TCM 18	LNMU 0303 TNGLY	1.622,00
ST448	16-Z2-W16 L200			1.785,00
ST449	16-Z2-W16 L250			1.915,00
ST450	17-Z2-W16 L160			1.622,00
ST451	17-Z2-W16 L200			1.785,00
ST452	18-Z2-W16 L150			1.660,00
ST453	20-Z3-W20 L160			1.785,00
ST454	20-Z3-W20 L200			1.993,00
ST455	21-Z3-W20 L160			1.785,00
ST456	21-Z3-W20 L200			1.909,00
ST458	22-Z3-W20 L160			1.785,00
ST459	25-Z4-W25 L160			2.159,00
ST460	25-Z4-W25 L200			2.285,00
ST461	26-Z4-W25 L160			2.159,00
ST462	26-Z4-W25 L200			2.285,00
ST463	26-Z4-W25 L250			2.408,00
ST464	32-Z4-W32 L160			2.324,00
ST465	32-Z4-W32 L200			2.450,00
ST466	33-Z4-W32 L160			2.337,00
ST467	33-Z4-W32 L200			2.450,00

SAPLI TARAMALAR

KOD	ÜRÜN AÇIKLAMASI	YEDEKLER	UÇ TİPİ	FİYATI
ST468	20-Z2-W20 L160	M3.5x11x4.8 TCM 35	RPMT 10T3 TNGLY	1.403,00
ST470	25-Z2-W25 L160			1.492,00
ST471	30-Z3-W25 L160			1.618,00
ST472	32-Z3-W32 L160			1.618,00
ST473	25-Z2-W25 L160	M4x11x5.3 TCM 42	RPMT 1204 TNGLY	1.492,00
ST474	30-Z3-W25 L160			1.618,00
ST475	32-Z3-W32 L160			1.618,00

SAPLI TARAMALAR

KOD	ÜRÜN AÇIKLAMASI	YEDEKLER	UÇ TİPİ	FİYATI
ST481	10-Z2-W09 L120	M1.8x4.2x2.4 TCM 02	AXMT 0602 TGTC	1.275,00
ST482	11-Z2-W10 L100			1.322,00
ST483	12-Z2-W11 L120			1.403,00
ST484	16-Z2-W15 L150	M2.5x7x3.5 TCM 18	APKT 09T3 TGTC	1.363,00
ST485	17-Z2-W16 L200			1.618,00
ST486	21-Z3-W20 L200			1.660,00

SAPLI TARAMALAR



KOD	ÜRÜN AÇIKLAMASI	YEDEKLER	UÇ TİPİ	FİYATI
ST487	12-Z2-W11 L120	M2x5x2.7	2PKT 0503	1.492,00
ST488	12-Z2-W12 L120	TCM 06	TGTC	1.492,00
ST490	20-Z2-W20 L150	M2.5x7x3.5 TCM 18	3PKT 1004 TGTC	1.829,00
ST491	25-Z3-W25 L150			1.958,00
ST492	32-Z4-W32 L150			2.127,00
ST492-1	32-Z3-W25 L150	M4.5x12x6.5	3PKT 1505	2.055,00
ST492-2	32-Z3-W32 L200	TCM 87	TGTC	2.224,00

SAPLI TARAMALAR



KOD	ÜRÜN AÇIKLAMASI	YEDEKLER	UÇ TİPİ	FİYATI
ST493	10-Z2-W10 L100	M1.8x4.2x2.4 TCM 02	4NKT 0402 TGTC	1.403,00
ST494	12-Z3-W12 L120			1.618,00
ST495	16-Z4-W16 L150			1.492,00
ST496-02	16-Z2-W16 L150 -IC	M3x8x4.2 TCM 29	4NKT 0603 TGTC	1.618,00
ST496-04	17-Z2-W16 L150 -IC			1.619,00
ST496-05	17-Z2-W16 L200 -IC			1.660,00
ST496-06	18-Z2-W16 L150 -IC			1.618,00
ST496-07	20-Z3-W20 L120 -IC			1.449,00
ST496-08	20-Z3-W20 L160 -IC			1.917,00
ST496-09	21-Z3-W20 L160 -IC			1.917,00
ST496-10	21-Z3-W20 L200 -IC			1.934,00
ST496-11	22-Z3-W20 L160 -IC			1.917,00
ST496-12	25-Z3-W25 L120 -IC			1.917,00
ST496-13	25-Z3-W25 L150 -IC			1.872,00
ST496-14	25-Z3-W25 L200 -IC			1.958,00
ST496-15	26-Z3-W25 L150 -IC			2.177,00
ST496-16	26-Z3-W25 L200 -IC			2.002,00
ST496-18	32-Z4-W32 L150 -IC			1.885,00
ST496-20	33-Z4-W32 L200 -IC			2.297,00

SAPLI TARAMALAR



KOD	ÜRÜN AÇIKLAMASI	YEDEKLER	UÇ TİPİ	FİYATI
ST507	16-Z2-W15 L150	M2.5x7x3.5 TCM 18	BLMP 0603 TGTC	1.492,00
ST508	16-Z2-W16 L150			1.492,00
ST509	17-Z2-W16 L100			1.403,00
ST510	17-Z2-W16 L150			1.532,00
ST511	17-Z2-W16 L200			1.700,00
ST512	20-Z3-W20 L150			1.575,00
ST513	21-Z3-W20 L150			1.575,00
ST514	21-Z3-W20 L200			1.748,00
ST515	25-Z4-W25 L150			1.917,00
ST516	26-Z4-W25 L150			1.958,00
ST517	26-Z4-W25 L200			2.213,00
ST518	32-Z5-W32 L200			2.297,00
ST519	33-Z5-W32 L200			2.297,00

SAPLI TARAMALAR

KOD	ÜRÜN AÇIKLAMASI	YEDEKLER	UÇ TİPİ	FİYATI
ST520	16-Z2-W16 L120	M3x8x4.2 TCM 29	LNGU 1104 KNMT	1.275,00
ST521	16-Z2-W16 L150			1.403,00
ST522	20-Z2-W20 L120			1.403,00
ST523	20-Z2-W20 L150			1.492,00
ST524	25-Z3-W25 L120			1.575,00
ST525	25-Z3-W25 L150			1.660,00

SAPLI TARAMALAR

KOD	ÜRÜN AÇIKLAMASI	YEDEKLER	UÇ TİPİ	FİYATI
ST526	16-Z2-W14 L120	M2.5x6x3.5 TCM 16	EDPT 10T3 KNMT	1.449,00
ST527	16-Z2-W16 L120			1.322,00
ST528	16-Z2-W16 L150			1.492,00
ST529	17-Z2-W16 L150			1.575,00
ST530	17-Z2-W16 L200			1.660,00
ST531	18-Z2-W16 L150			1.532,00
ST532	20-Z3-W20 L150	M2.5x7x3.5 TCM 18	EDPT 1404 KNMT	1.575,00
ST533	21-Z3-W20 L150			1.618,00
ST534	22-Z3-W20 L150			1.660,00
ST535	22-Z3-W20 L200			1.787,00
ST536	25-Z3-W25 L150			1.829,00
ST537	20-Z2-W20 L120			M3x8x4.2 TCM 29
ST538	20-Z2-W20 L150	1.575,00		
ST539	25-Z3-W25 L120	1.700,00		
ST540	25-Z3-W25 L150	1.829,00		
ST541	25-Z2-W25 L200	1.872,00		
ST542	32-Z3-W32 L200	2.044,00		

SAPLI TARAMALAR

KOD	ÜRÜN AÇIKLAMASI	YEDEKLER	UÇ TİPİ	FİYATI
ST543	16-Z2-W16 L150	M2.5x6x3.5 TCM 16	AOMT 1236 MİTSB	1.363,00
ST545	17-Z2-W16 L150			1.449,00
ST546	20-Z3-W20 L150	M2.5x7x3.5 TCM 18		1.532,00
ST547	20-Z3-W20 L200			1.748,00
ST548	21-Z3-W20 L150			1.532,00
ST549	25-Z4-W25 L150			1.532,00
ST550	25-Z4-W25 L200			1.657,00
ST551	32-Z4-W32 L150			1.660,00
ST552	32-Z4-W32 L200			1.917,00

SAPLI TARAMALAR



KOD	ÜRÜN AÇIKLAMASI	YEDEKLER	UÇ TİPİ	FİYATI
ST553	25-Z2-W25 L150	M4x11x5.3 TCM 42	AOMT 1848 MİTSB	1.618,00
ST554	32-Z3-W32 L150			1.748,00

SAPLI TARAMALAR



KOD	ÜRÜN AÇIKLAMASI	YEDEKLER	UÇ TİPİ	FİYATI
ST555	32-Z2-W32 L150	M5x12x7 TCM 46	SOMT 12T3 MİTSB	1.787,00
ST556	40-Z3-W32 L150			2.002,00

SAPLI TARAMALAR



KOD	ÜRÜN AÇIKLAMASI	YEDEKLER	UÇ TİPİ	FİYATI
ST557	16-Z2-W15 L160	M2.5x6x3.5 TCM 16	APMT 1135 SANG	1.326,00
ST558	16-Z2-W16 L160			1.326,00
ST559	16-Z2-W16 L200			1.458,00
ST560	17-Z2-W16 L160	M2.5x7x3.5 TCM 18	APMT 1135 SANG	1.417,00
ST561	17-Z2-W16 L200			1.458,00
ST562	20-Z3-W20 L160			1.458,00
ST563	20-Z3-W20 L200			1.638,00
ST564	21-Z3-W20 L160			1.550,00
ST565	21-Z3-W20 L160			1.726,00
ST566	25-Z3-W25 L160			1.550,00
ST567	25-Z3-W25 L200			1.768,00
ST568	26-Z3-W25 L160			1.550,00
ST569	26-Z3-W25 L200			1.768,00
ST570	32-Z4-W32 L160	1.726,00		
ST571	33-Z4-W32 L160	1.768,00		

SAPLI TARAMALAR



KOD	ÜRÜN AÇIKLAMASI	YEDEKLER	UÇ TİPİ	FİYATI
ST577	16-Z2-W16 L160	M2.5x7x3.5 TCM 18	RDMX 0802 SANG	1.241,00
ST578	20-Z2-W20 L160			1.326,00

SAPLI TARAMALAR



KOD	ÜRÜN AÇIKLAMASI	YEDEKLER	UÇ TİPİ	FİYATI
ST582	20-Z2-W20 L160	M3x8x4.2 TCM 29	SOMW 0803 SANG	1.458,00
ST583	20-Z2-W20 L200			1.576,00
ST584	25-Z3-W25 L160			1.638,00
ST585	25-Z3-W25 L200			1.794,00
ST585-1	26-Z3-W25 L200			1.726,00

SAPLI TARAMALAR

KOD	ÜRÜN AÇIKLAMASI	YEDEKLER	UÇ TİPİ	FİYATI
ST585-2	32-Z4-W32 L160	M3x8x4.2 TCM 29	SOMW 0803 SANG	2.081,00
ST585-3	32-Z4-W32 L200			2.256,00

SAPLI TARAMALAR

KOD	ÜRÜN AÇIKLAMASI	YEDEKLER	UÇ TİPİ	FİYATI
ST586	32-Z2-W32 L160	 M4x11x5.3 TCM 42  KEP 13  M4x11x5.3 TCM 42	SPMW 1204 SANG	1.726,00

SAPLI TARAMALAR

KOD	ÜRÜN AÇIKLAMASI	YEDEKLER	UÇ TİPİ	FİYATI
ST590	33-Z3-W32 L150	M3x8x4.2 TCM 29	SDMT 1004 BHLR	1.872,00
ST591	33-Z3-W32 L200			2.085,00

SAPLI TARAMALAR

KOD	ÜRÜN AÇIKLAMASI	YEDEKLER	UÇ TİPİ	FİYATI
ST710	16-Z2-W16 L150	M2.5x6x3.5 TCM 16	BOMT 09T3 İNGRSL	1.363,00
ST711	18-Z2-W16 L150			1.403,00
ST712	20-Z3-W20 L150	M2.5x7x3.5 TCM 18	BOMT 1304 İNGRSL	1.532,00
ST713	22-Z3-W20 L150			1.618,00
ST598	20-Z2-W20 L150	M3x8x4.2 TCM 29	BOMT 1304 İNGRSL	1.363,00
ST599	22-Z2-W20 L150			1.403,00
ST600	25-Z2-W25 L150			1.532,00
ST601	32-Z4-W25 L150			1.618,00
ST602	32-Z4-W32 L150			1.618,00

SAPLI TARAMALAR

KOD	ÜRÜN AÇIKLAMASI	YEDEKLER	UÇ TİPİ	FİYATI
ST603	09-Z2-W10 L075	M2x5x2.7 TCM 06	LPGT 0102 KYCR	1.541,00
ST604	10-Z2-W10 L100			1.587,00
ST605	10-Z2-W09 L120			1.639,00
ST606	11-Z2-W10 L120			1.688,00
ST607	12-Z2-W12 L100			1.639,00
ST608	12-Z2-W11 L120			1.734,00
ST609	12-Z2-W12 L120			1.734,00
ST610	12-Z3-W11 L120			1.783,00
ST611	12-Z3-W12 L120			1.783,00
ST612	12-Z3-W12 L150			1.879,00
ST613	16-Z4-W16 L160			2.119,00

SAPLI TARAMALAR



KOD	ÜRÜN AÇIKLAMASI	YEDEKLER	UÇ TİPİ	FİYATI
ST703	16-Z2-W15 L150	M2.5x6x3.5 TCM 16	XDKT 11T3 CRTZ	1.363,00
ST704	20-Z3-W19 L150	M2.5x7x3.5 TCM 18		1.403,00
ST705	25-Z3-W24 L150			1.492,00
ST706	32-Z4-W25 L150			1.660,00

SAPLI TARAMALAR



KOD	ÜRÜN AÇIKLAMASI	YEDEKLER	UÇ TİPİ	FİYATI
ST714	10-Z2-W09 L120	M1.8x4.2x2.4 TCM 02	JDMT 0702 DES	1.275,00
ST715	12-Z2-W11 L120			1.403,00
ST716	17-Z3-W16 L150			1.528,00
ST717	21-Z4-W20 L150			1.707,00

SAPLI TARAMALAR



KOD	ÜRÜN AÇIKLAMASI	YEDEKLER	UÇ TİPİ	FİYATI
ST720	10-Z2-W10 L120	M1.8x4.2x2.4 TCM 02	LPMW 0402 KRLY	1.748,00
ST721	12-Z3-W12 L120			1.829,00
ST722	14-Z3-W12 L120			1.872,00
ST723	16-Z4-W16 L120			1.917,00
ST724	16-Z4-W16 L150			2.044,00

SAPLI TARAMALAR



KOD	ÜRÜN AÇIKLAMASI	YEDEKLER	UÇ TİPİ	FİYATI
KÜRE01	KÜRE 10.130.10 WALTER	M4x9 TCM 65	P3201-D10	1.363,00
KÜRE02	KÜRE 12.130.12 WALTER	M5x10 TCM 66	P3204-D12	1.449,00
KÜRE03	KÜRE 16.140.16 WALTER	M5x12 TCM 67	P3204-D16	1.492,00
KÜRE04	KÜRE 20.160.20 WALTER	M5x16 TCM 68	P3204-D20	1.787,00
KÜRE05	KÜRE 25.160.25 WALTER	M5x22 TCM 69	P3204-D25	1.787,00

SAPLI TARAMALAR



KOD	ÜRÜN AÇIKLAMASI	YEDEKLER	UÇ TİPİ	FİYATI
ST800	16-Z2-W16 L150	M2.5x6x3.5 TCM 16	ENMX 08T3 WLTR	1.618,00
ST802	16-Z2-W16 L200	M2.5x7x3.5 TCM 18		1.787,00
ST804	20-Z3-W20 L150			1.787,00
ST806	20-Z3-W20 L200			1.900,00
ST808	25-Z4-W25 L150	2.127,00		

SAPLI TARAMALAR

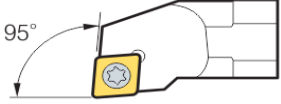

KOD	ÜRÜN AÇIKLAMASI	YEDEKLER	UÇ TİPİ	FİYATI
ST810	20-Z2-W20 L150	M3.5x8x5.3 TCM 33	RDMW 10T3 İSO	1.233,00
ST812	25-Z2-W25 L150			1.403,00
ST814	25-Z2-W25 L200			1.575,00
ST816	32-Z3-W32 L160			1.492,00
ST818	40-Z4-W32 L150			1.872,00
ST820	40-Z4-W32 L250			2.213,00

İÇ PASO KATERLERİ
95°

KOD	ÜRÜN AÇIKLAMASI	YEDEKLER	UÇ TİPİ	FİYATI
İP100	S06-08H SCLCR 06	M2.5x5x3.5 TCM 14	CCMT 0602 İSO	417,00
İP102	S08H SCLCR 06			417,00
İP105	S10K SCLCR 06			417,00
İP105-1	S10-12K SCLCR 06			483,00
İP106	S12M SCLCR 06	M2.5x7x3.5 TCM 18	CCMT 0602 İSO	462,00
İP106-1	S12-16M SCLCR 06			512,00
İP110-1	S16Q SCLCR 06			524,00
İP107-1	S12M SCLCR 09	M3.5x8x5.3 TCM 33	CCMT 09T3 İSO	489,00
İP107-2	S12-16M SCLCR 09			512,00
İP110	S16Q SCLCR 09	M3.5x10x5.3 TCM 34	CCMT 09T3 İSO	524,00
İP114	S20R SCLCR 09			590,00
İP116	S25S SCLCR 09			734,00
İP117	S32T SCLCR 09			1.089,00
İP116-1	S25S SCLCR 12 ALTLIKLI	TAM 17 TCM 78 M4x14x7 TCM 45	CCMT 1204 İSO	734,00
İP118	S32T SCLCR 12 ALTLIKLI			1.089,00
İP119	S40V SCLCR 12 ALTLIKLI			1.885,00

İÇ PASO KATERLERİ
95°

KOD	ÜRÜN AÇIKLAMASI	YEDEKLER	UÇ TİPİ	FİYATI
İP230	S06-08H SCLCL 06	M2.5x5x3.5 TCM 14	CCMT 0602 İSO	417,00
İP232	S08H SCLCL 06			417,00
İP234	S10K SCLCL 06			417,00
İP234-1	S10-12K SCLCL 06			483,00
İP236	S12M SCLCL 06	M2.5x7x3.5 TCM 18	CCMT 0602 İSO	462,00
İP236-1	S16Q SCLCL 06			524,00
İP240	S12M SCLCL 09	M3.5x8x5.3 TCM 33	CCMT 09T3 İSO	489,00
İP241	S16Q SCLCL 09			524,00
İP244	S20R SCLCL 09	M3.5x10x5.3 TCM 34	CCMT 09T3 İSO	590,00
İP245	S25S SCLCL 09			734,00
İP246	S32T SCLCL 09			1.089,00
İP247	S25S SCLCL 12 ALTLIKLI			TAM 17 TCM 78 M4x14x7 TCM 45
İP248	S32T SCLCL 12 ALTLIKLI	1.089,00		
İP249	S40V SCLCL 12 ALTLIKLI	1.885,00		

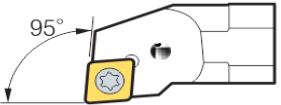

İÇ PASO KATERLERİ
95°

KOD	ÜRÜN AÇIKLAMASI	YEDEKLER	UÇ TİPİ	FİYATI
İPA100	A06-08H SCLCR 06 -IC	M2.5x5x3.5 TCM 14	CCMT 0602 İSO	590,00
İPA102	A08H SCLCR 06 -IC			590,00
İPA105	A10K SCLCR 06 -IC			590,00
İPA106	A12M SCLCR 06 -IC	M2.5x7x3.5 TCM 18	CCMT 0602 İSO	630,00
İPA107-1	A12M SCLCR 09 -IC	M3.5x8x5.3 TCM 33		CCMT 09T3 İSO
İPA110	A16Q SCLCR 09 -IC		672,00	
İPA110-1	A16Q SCLCR 06 -IC	M3.5x10x5.3 TCM 34	CCMT 09T3 İSO	672,00
İPA114	A20R SCLCR 09 -IC			757,00
İPA116-1	A25S SCLCR 12 -IC ALTLIKLI	TAM 17 TCM 78 4x14x7 TCM 45	CCMT 1204	838,00

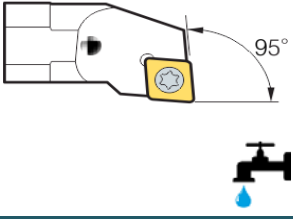

İÇ PASO KATERLERİ

95°



KOD	ÜRÜN AÇIKLAMASI	YEDEKLER	UÇ TİPİ	FİYATI
İPA230	A06-08H SCLCL 06 -IC	M2.5x5x3.5 TCM 14	CCMT 0602 İSO	590,00
İPA232	A08H SCLCL 06 -IC			590,00
İPA234	A10K SCLCL 06 -IC			590,00
İPA236	A12M SCLCL 06 -IC	M2.5x7x3.5 TCM 18	CCMT 09T3 İSO	630,00
İPA236-1	A16Q SCLCL 06 -IC			672,00
İPA240	A12M SCLCL 09 -IC	M3.5x8x5.3 TCM 33	CCMT 09T3 İSO	630,00
İPA241	A16Q SCLCL 09 -IC			672,00
İPA244	A20R SCLCL 09 -IC			M3.5x10x5.3 TCM 34

İÇ PASO KATERLERİ

93°

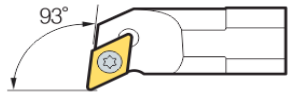

KOD	ÜRÜN AÇIKLAMASI	YEDEKLER	UÇ TİPİ	FİYATI
İP120	S10K SDUCR 07	M2.5x5x3.5 TCM 14	DCMT 0702 İSO	417,00
İP122	S12M SDUCR 07			462,00
İP123	S16Q SDUCR 07	M2.5x7x3.5 TCM 18		524,00
İP124	S20R SDUCR 07			568,00
İP125	S25S SDUCR 07			672,00

İÇ PASO KATERLERİ

93°

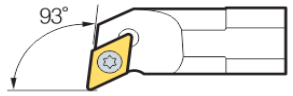

KOD	ÜRÜN AÇIKLAMASI	YEDEKLER	UÇ TİPİ	FİYATI
İP128	S16Q SDUCR 11	M3.5x8x5.3 TCM 33	DCMT 11T3 İSO	524,00
İP130	S20R SDUCR 11			568,00
İP132	S25S SDUCR 11 ALTLIKLI	TAM 13 TCM 76 3.5x14x5.3 TCM 38		672,00
İP134	S32T SDUCR 11 ALTLIKLI			1.180,00
İP136	S40V SDUCR 11 ALTLIKLI			1.885,00

İÇ PASO KATERLERİ

93°

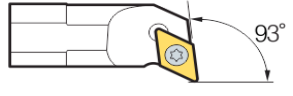

KOD	ÜRÜN AÇIKLAMASI	YEDEKLER	UÇ TİPİ	FİYATI
İP250	S10K SDUCL 07	M2.5x5x3.5 TCM 14	DCMT 0702 İSO	417,00
İP252	S12M SDUCL 07			462,00
İP253	S16Q SDUCL 07	M2.5x7x3.5 TCM 18		524,00
İP254	S20R SDUCL 07			568,00
İP255	S25S SDUCL 07			672,00
İP258	S16Q SDUCL 11	M3.5x8x5.3 TCM 33	DCMT 11T3 İSO	524,00
İP260	S20R SDUCL 11			568,00
İP262	S25S SDUCL 11 ALTLIKLI	TAM 13 TCM 76 3.5x14x5.3 TCM 38		672,00
İP263	S32T SDUCL 11 ALTLIKLI			1.180,00
İP264	S40V SDUCL 11 ALTLIKLI			1.885,00

İÇ PASO KATERLERİ

93°

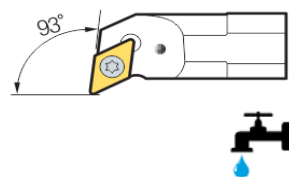

KOD	ÜRÜN AÇIKLAMASI	YEDEKLER	UÇ TİPİ	FİYATI
İPA120	A10K SDUCR 07 -IC	M2.5x5x3.5 TCM 14	DCMT 0702 İSO	543,00
İPA122	A12M SDUCR 07 -IC	M2.5x7x3.5 TCM 18		672,00
İPA128	A16Q SDUCR 11 -IC	M3.5x8x5.3 TCM 33	DCMT 11T3 İSO	672,00
İPA130	A20R SDUCR 11 -IC			757,00
İPA132	A25S SDUCR 11 -IC ALTLIKLI	M3.5x14x5.3 TCM 38		857,00

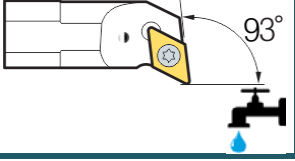
İÇ PASO KATERLERİ
93°

KOD	ÜRÜN AÇIKLAMASI	YEDEKLER	UÇ TİPİ	FİYATI
İPA250	A10K SDUCL 07 -IC	M2.5x5x3.5 TCM 14	DCMT 0702 İSO	590,00
İPA251	A12M SDUCL 07 -IC	M2.5x7x3.5 TCM 18		672,00
İPA258	A16Q SDUCL 11 -IC	M3.5x8x5.3 TCM 33	DCMT 11T3 İSO	672,00
İPA260	A20R SDUCL 11 -IC			757,00
İPA262	A25S SDUCL 11 -IC ALTLIKLI	M3.5x14x5.3 TCM 38		857,00

İÇ PASO KATERLERİ
107.5°



KOD	ÜRÜN AÇIKLAMASI	YEDEKLER	UÇ TİPİ	FİYATI
İP141	S12M SDQCR 07	M2.5x5x3.5 TCM 14	DCMT 0702 İSO	462,00
İP142	S16Q SDQCR 07	M2.5x7x3.5 TCM 18		524,00
İP143	S20R SDQCR 07			568,00
İP144	S25S SDQCR 07			672,00
İP146	S16Q SDQCR 11	M3.5x8x5.3 TCM 33	DCMT 11T3 İSO	524,00
İP148	S20R SDQCR 11			568,00
İP150	S25S SDQCR 11 ALTLIKLI	TAM 13 TCM 76 TCM 38 3.5x14x5.3		672,00
İP152	S32T SDQCR 11 ALTLIKLI			1.180,00
İP153	S40V SDQCR 11 ALTLIKLI		1.808,00	

İÇ PASO KATERLERİ
107.5°

KOD	ÜRÜN AÇIKLAMASI	YEDEKLER	UÇ TİPİ	FİYATI
İP270	S10K SDQCL 07	M2.5x5x3.5 TCM 14	DCMT 0702 İSO	417,00
İP271	S12M SDQCL 07	M2.5x7x3.5 TCM 18		462,00
İP272	S16Q SDQCL 07			524,00
İP273	S20R SDQCL 07			568,00
İP274	S25S SDQCL 07			672,00
İP276	S16Q SDQCL 11	M3.5x8x5.3 TCM 33	DCMT 11T3 İSO	524,00
İP278	S20R SDQCL 11			568,00
İP280	S25S SDQCL 11 ALTLIKLI	TAM 13 TCM 76 TCM 38 3.5x14x5.3		672,00
İP281	S32T SDQCL 11 ALTLIKLI			1.180,00
İP281-1	S40V SDQCL 11 ALTLIKLI		1.808,00	

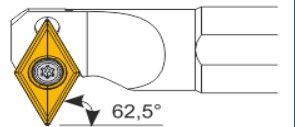

İÇ PASO KATERLERİ
107.5°

KOD	ÜRÜN AÇIKLAMASI	YEDEKLER	UÇ TİPİ	FİYATI
İPA140	A10K SDQCR 07 -IC	M2.5x5x3.5 TCM 14	DCMT 0702 İSO	590,00
İPA141	A12M SDQCR 07 -IC	M2.5x7x3.5 TCM 18		630,00
İPA146	A16Q SDQCR 11 -IC	M3.5x8x5.3 TCM 33	DCMT 11T3 İSO	714,00
İPA148	A20R SDQCR 11 -IC			757,00

İÇ PASO KATERLERİ
62.5°

KOD	ÜRÜN AÇIKLAMASI	YEDEKLER	UÇ TİPİ	FİYATI
İP168	S10J SD-CR 07	M2.5x5x3.5 TCM 14	DCMT 0702 İSO	462,00
İP170	S12M SD-CR 07	M2.5x7x3.5 TCM 18		462,00
İP172	S16Q SD-CR 07			524,00
İP173	S16Q SD-CR 11	M3.5x8x5.3 TCM 33	DCMT 11T3 İSO	524,00
İP174	S20R SD-CR 11			568,00
İP176	S25S SD-CR 11 ALTLIKLI	TAM 13 TCM 76 TCM 38 3.5x14x5.3		672,00
İP178	S32T SD-CR 11 ALTLIKLI			1.180,00
İP179	S40V SD-CR 11 ALTLIKLI		1.885,00	

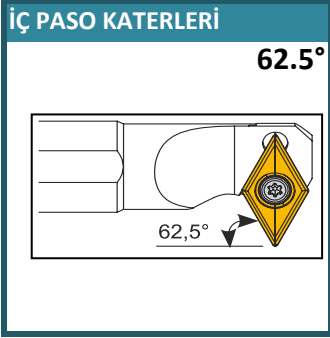



KOD	ÜRÜN AÇIKLAMASI	YEDEKLER	UÇ TİPİ	FİYATI
İP180	S10J SD-CL 07	M2.5x5x3.5 TCM 14	DCMT 0702 İSO	462,00
İP181	S12M SD-CL 07	M2.5x7x3.5		462,00
İP182	S16Q SD-CL 07	TCM 18		524,00
İP182-1	S16Q SD-CL 11	M3.5x8x5.3	DCMT 11T3 İSO	524,00
İP183	S20R SD-CL 11	TCM 33		568,00
İP184	S25S SD-CL 11 ALTLIKLI	TAM 13		672,00
İP185	S32T SD-CL 11 ALTLIKLI	TCM 76		1.180,00
İP185-1	S40V SD-CL 11 ALTLIKLI	TCM 38 3.5x14x5.3		1.885,00

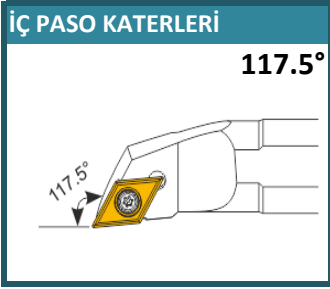

KOD	ÜRÜN AÇIKLAMASI	YEDEKLER	UÇ TİPİ	FİYATI
İP465	S10K SDPCR 07	M2.5x5x3.5 TCM 14	DCMT 0702	417,00
İP466	S12M SDPCR 07	M2.5x7x3.5 TCM 18	İSO	462,00
İP467	S16Q SDPCR 11	M3.5x8x5.3	DCMT 11T3 İSO	524,00
İP468	S20R SDPCR 11	TCM 33		568,00
İP469	S25S SDPCR 11 ALTLIKLI	TAM 13		672,00
İP470	S32T SDPCR 11 ALTLIKLI	TCM 76		1.180,00
		TCM 38 3.5x14		

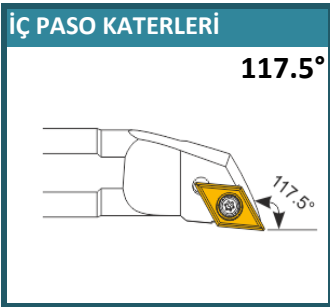

KOD	ÜRÜN AÇIKLAMASI	YEDEKLER	UÇ TİPİ	FİYATI
İP471	S10K SDPCL 07	M2.5x5x3.5 TCM 14	DCMT 0702	417,00
İP472	S12M SDPCL 07	M2.5x7x3.5 TCM 18	İSO	462,00
İP473	S16Q SDPCL 11	M3.5x8x5.3	DCMT 11T3 İSO	524,00
İP474	S20R SDPCL 11	TCM 33		568,00
İP475	S25S SDPCL 11 ALTLIKLI	TAM 13		672,00
İP475-1	S32T SDPCL 11 ALTLIKLI	TCM 76		1.180,00
		TCM 38 3.5x14		



KOD	ÜRÜN AÇIKLAMASI	YEDEKLER	UÇ TİPİ	FİYATI
İP190	S12M SDXCR 07	M2.5x5x3.5 TCM 14	DCMT 0702	462,00
İP191	S16Q SDXCR 07	M2.5x7x3.5 TCM 18	İSO	524,00
İP192	S16Q SDXCR 11	M3.5x8x5.3	DCMT 11T3 İSO	524,00
İP193	S20R SDXCR 11	TCM 33		568,00
İP194	S25S SDXCR 11 ALTLIKLI	TAM 13		672,00
İP195	S32T SDXCR 11 ALTLIKLI	TCM 76		1.180,00
İP196	S40V SDXCR 11 ALTLIKLI	TCM 38 3.5x14x5.3		1.885,00

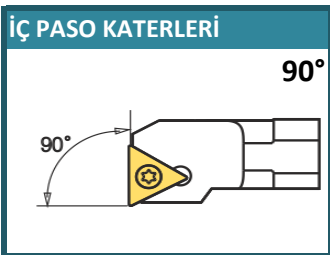

KOD	ÜRÜN AÇIKLAMASI	YEDEKLER	UÇ TİPİ	FİYATI
İP160	S12M STFCR 11	M2.5x7x3.5 TCM 18	TCMT 1102	503,00
İP162	S16Q STFCR 16	M3.5x8x5.3 TCM 33	TCMT 16T3 İSO	524,00
İP164	S20R STFCR 16 ALTLIKLI	TAM 16		568,00
İP166	S25S STFCR 16 ALTLIKLI	TCM 76		672,00
İP167	S32T STFCR 16 ALTLIKLI	TCM 34 M3.5x10		1.180,00

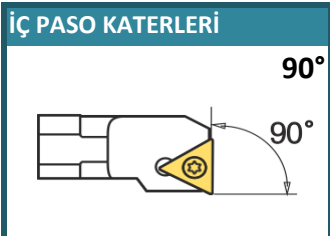

KOD	ÜRÜN AÇIKLAMASI	YEDEKLER	UÇ TİPİ	FİYATI
İP186	S16Q STFCL 16	M3.5x8x5.3 TCM 33	TCMT 16T3 İSO	524,00
İP187	S20R STFCL 16 ALTLIKLI	TAM 16		568,00
İP188	S25S STFCL 16 ALTLIKLI	TCM 76		672,00
İP189	S32T STFCL 16 ALTLIKLI	TCM 34 M3.5x10		1.180,00

İÇ PASO KATERLERİ
93°

KOD	ÜRÜN AÇIKLAMASI	YEDEKLER	UÇ TİPİ	FİYATI
İP198	S25S SVJBR 16 SAĞ	TAM 14 TCM 76 M3.5x14 TCM 38	VBMT 1604 İSO	757,00
İP199	S32T SVJBR 16 SAĞ			1.180,00
İP200	S40V SVJBR 16 SAĞ			1.885,00

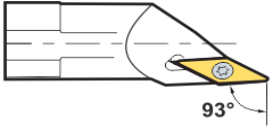

İÇ PASO KATERLERİ
93°

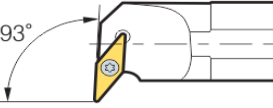
KOD	ÜRÜN AÇIKLAMASI	YEDEKLER	UÇ TİPİ	FİYATI
İP201	S25S SVJBL 16	TAM 14 TCM 76 M3.5x14 TCM 38	VBMT 1604 İSO	757,00
İP202	S32T SVJBL 16			1.180,00

İÇ PASO KATERLERİ
93°

KOD	ÜRÜN AÇIKLAMASI	YEDEKLER	UÇ TİPİ	FİYATI
İP206	S16Q SVUBR 11	M2.5x7x3.5	VBMT 1102	630,00
İP207	S20R SVUBR 11	TCM 18	İSO	734,00

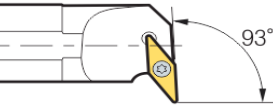
İP208	S25S SVUBR 16	TAM 14 TCM 76 M3.5x14 TCM 38	VBMT 1604 İSO	757,00
İP209	S32T SVUBR 16			1.180,00
İP210	S40V SVUBR 16			1.885,00

İÇ PASO KATERLERİ
93°

KOD	ÜRÜN AÇIKLAMASI	YEDEKLER	UÇ TİPİ	FİYATI
İP282	S16Q SVUBL 11	M2.5x7x3.5	VBMT 1102	630,00
İP284	S20R SVUBL 11	TCM 18	İSO	734,00

İP286	S25S SVUBL 16	TAM 14 TCM 76 M3.5x14 TCM 38	VBMT 1604 İSO	757,00
İP288	S32S SVUBL 16			1.180,00
İP289	S40V SVUBL 16			1.808,00

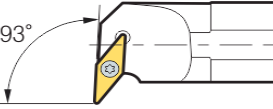
İÇ PASO KATERLERİ
93°

KOD	ÜRÜN AÇIKLAMASI	YEDEKLER	UÇ TİPİ	FİYATI
İP211	S16Q SVUCR 11	M2.5x7x3.5	VCMT 1102	630,00
İP212	S20Q SVUCR 11	TCM 18	İSO	734,00

İP213	S25S SVUCR 16	TAM 15 TCM 76 M3.5x14 TCM 38	VCMT 1604 İSO	757,00
İP214	S32T SVUCR 16			1.180,00
İP215	S40V SVUCR 16			1.885,00

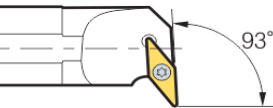
İÇ PASO KATERLERİ
93°

KOD	ÜRÜN AÇIKLAMASI	YEDEKLER	UÇ TİPİ	FİYATI
İP300	S16Q SVUCL 11	M2.5x7x3.5	VCMT 1102	630,00
İP302	S20R SVUCL 11	TCM 18	İSO	734,00

İP304	S25S SVUCL 16	TAM 15 TCM 76 M3.5x14 TCM 38	VCMT 1604 İSO	757,00
İP306	S32S SVUCL 16			1.180,00
İP307	S40V SVUCL 16			1.808,00



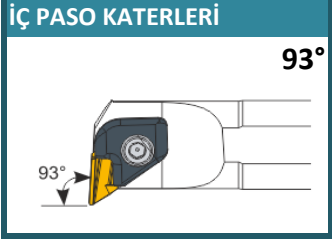

KOD	ÜRÜN AÇIKLAMASI	YEDEKLER	UÇ TİPİ	FİYATI
İP750	S25S CKUNR 16 SAÇ KEP	TAM 22 M3x10 TCM58 KEP 16 M6x27 TCM 50	KNUX 1604-L İSO	774,00
İP754	S32T CKUNR 16 ORJ.KEP			1.063,00
İP756	S40V CKUNR 16 ORJ.KEP			1.905,00
İP758	S50W CKUNR 16 ORJ.KEP			2.524,00
İP760	S60W CKUNR 16 ORJ.KEP			3.539,00

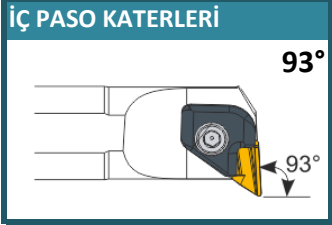

KOD	ÜRÜN AÇIKLAMASI	YEDEKLER	UÇ TİPİ	FİYATI
İP762	S25S CKUNL 16 SAÇ KEP	TAM 21 M3x10 KEP 16 M6x27	KNUX 1604-R İSO	774,00
İP764	S32T CKUNL 16 ORJ.KEP			1.063,00
İP766	S40V CKUNL 16 ORJ.KEP			1.905,00

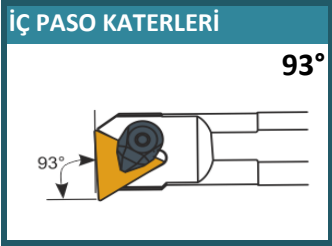

KOD	ÜRÜN AÇIKLAMASI	YEDEKLER	UÇ TİPİ	FİYATI
RKM196	S16Q CTUPR 16	* * *	TPKN 1603 İSO	734,00
RKM198	S20R CTUPR 16	TAM 23 M5x10 KEP 13 TCM 34		734,00
RKM200	S25S CTUPR 16			757,00
RKM202	S25S CTUPL 16-SOL			757,00

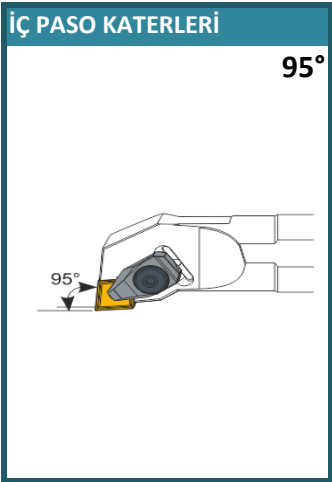

KOD	ÜRÜN AÇIKLAMASI	YEDEKLER	UÇ TİPİ	FİYATI
İP399	S20R TCLNR 12	* * *	CNMG 1204 İSO	880,00
İP400	S25S TCLNR 12	TAM 03 TCM 60 KEP 02 M6x27 TCM 50		1.028,00
İP402	S32T TCLNR 12			1.305,00
İP404	S40V TCLNR 12			2.030,00
İP370	S32T TCLNR 16	TAM 05 TCM 62 KEP 03 TCM 50	CNMG 1606 İSO	1.526,00
İP370-1	S40V TCLNR 16			2.203,00
İP371	S50W TCLNR 16			2.575,00
İP371-1	S60W TCLNR 16			3.539,00
İP372	S40V TCLNR 19	TAM 06 TCM 51 KEP 04	CNMG 1906 İSO	2.203,00
İP372-1	S50W TCLNR 19			3.095,00

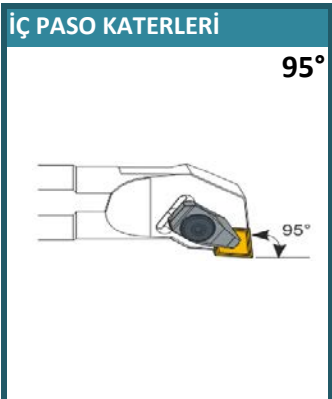

KOD	ÜRÜN AÇIKLAMASI	YEDEKLER	UÇ TİPİ	FİYATI
İP480	S25S TCLNL 12	TAM 03 TCM 60 KEP 02 M6x27 TCM 50	CNMG 1204 İSO	1.028,00
İP482	S32T TCLNL 12			1.305,00
İP484	S40V TCLNL 12			2.030,00
İP373	S32T TCLNL 16	TAM 05 TCM 62 KEP 03 TCM 50	CNMG 1606 İSO	1.526,00
İP373-1	S40V TCLNL 16			2.203,00
İP374	S50W TCLNL 16			2.575,00
İP374-1	S60W TCLNL 16			3.539,00
İP375	S40V TCLNL 19	TAM 06 KEP 04	CNMG 1906	2.203,00

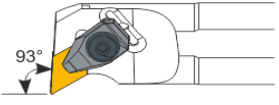
İÇ PASO KATERLERİ
93°

KOD	ÜRÜN AÇIKLAMASI	YEDEKLER	UÇ TİPİ	FİYATI
İP408	S20R TDUNR 11	* * KEP 01 TCM 49	DNMG 1104	963,00
İP410	S25S TDUNR 15	TAM 02 TCM 60 KEP 02 M6x27 TCM 50	DNMG 1506 İSO	1.028,00
İP412	S32T TDUNR 15			1.305,00
İP414	S40V TDUNR 15			2.030,00
İP416	S50W TDUNR 15			2.575,00
İP417	S60W TDUNR 15			3.539,00

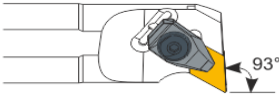
İÇ PASO KATERLERİ
93°

KOD	ÜRÜN AÇIKLAMASI	YEDEKLER	UÇ TİPİ	FİYATI
İP487	S20R TDUNL 11	* * KEP 01 TCM 49	DNMG 1104	963,00
İP490	S25S TDUNL 15	TAM 02 TCM 60 KEP 02 M6x27 TCM 50	DNMG 1506 İSO	1.028,00
İP492	S32T TDUNL 15			1.305,00
İP494	S40V TDUNL 15			2.030,00
İP496	S50W TDUNL 15			2.575,00
İP497	S60W TDUNL 15			3.539,00

İÇ PASO KATERLERİ
62.5°

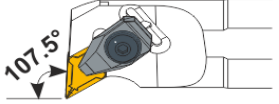

KOD	ÜRÜN AÇIKLAMASI	YEDEKLER	UÇ TİPİ	FİYATI
İP462	S32T TD-NR 15	TAM 02 TCM 60 KEP 02 TCM 50	DNMG 1506 İSO	1.305,00
İP463	S40V TD-NR 15			2.030,00
İP464	S50W TD-NR 15			2.575,00

İÇ PASO KATERLERİ
107.5°

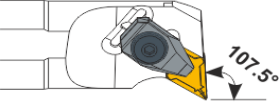
KOD	ÜRÜN AÇIKLAMASI	YEDEKLER	UÇ TİPİ	FİYATI
İP476	S25S TDQNR 15	TAM 02 TCM 60 KEP 02 M6x27 TCM 50	DNMG 1506 İSO	1.028,00
İP477	S32T TDQNR 15			1.305,00
İP478	S40V TDQNR 15			2.030,00
İP479	S50W TDQNR 15			2.575,00

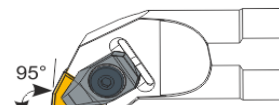

İÇ PASO KATERLERİ
107.5°

KOD	ÜRÜN AÇIKLAMASI	YEDEKLER	UÇ TİPİ	FİYATI
İP533	S25S TDQNL 15	TAM 02 TCM 60 KEP 02 M6x27 TCM 50	DNMG 1506 İSO	1.028,00
İP534	S32T TDQNL 15			1.305,00
İP535	S40V TDQNL 15			2.030,00
İP536	S50W TDQNL 15			2.575,00

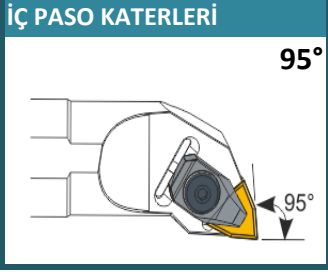

İÇ PASO KATERLERİ
95°

KOD	ÜRÜN AÇIKLAMASI	YEDEKLER	UÇ TİPİ	FİYATI
İP418	S20R TWLNR 06	* * KEP 05 TCM 49	WNMG 0604	963,00
İP420	S25S TWLNR 08	TAM 12 TCM 60 KEP 02 M6x27 TCM 50	WNMG 0804 İSO	1.028,00
İP422	S32T TWLNR 08			1.305,00
İP424	S40V TWLNR 08			2.030,00
İP426	S50W TWLNR 08			2.575,00
İP426-1	S60W TWLNR 08			3.539,00



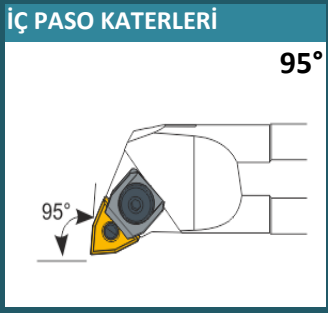

KOD	ÜRÜN AÇIKLAMASI	YEDEKLER				UÇ TİPİ	FİYATI
İP498	S20R TWLNL 06	*	*	KEP 05	TAM 49	WNMG 0604	963,00
İP500	S25S TWLNL 08	TAM 12	TCM 60	KEP 02	M6x27 TCM 50	WNMG 0804 İSO	1.028,00
İP502	S32T TWLNL 08						1.305,00
İP504	S40V TWLNL 08						2.030,00
İP506	S50W TWLNL 08						2.575,00



KOD	ÜRÜN AÇIKLAMASI	YEDEKLER				UÇ TİPİ	FİYATI	
İP427	S16Q MWLNR 06	*	*	PİM 01	KEP 05	TCM 49	WNMG 0604	880,00
İP427-1	S20R MWLNR 06	*	*				İSO	963,00
İP428	S25S MWLNR 08	TAM 12	PİM 02	KEP 06	M6x27 TCM 50	WNMG 0804 İSO	1.089,00	
İP430	S32T MWLNR 08						1.483,00	
İP432	S40V MWLNR 08						2.030,00	
İP434	S50W MWLNR 08						2.575,00	

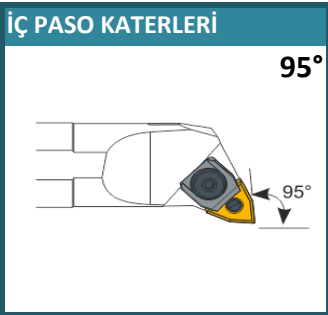

KOD	ÜRÜN AÇIKLAMASI	YEDEKLER				UÇ TİPİ	FİYATI	
İP507	S16Q MWLNL 06	*	*	PİM 01	KEP 05	TCM 49	WNMG 0604	880,00
İP508	S20R MWLNL 06	*	*				İSO	963,00
İP510	S25S MWLNL 08	TAM 12	PİM 02	KEP 06	M6x27 TCM 50	WNMG 0804 İSO	1.089,00	
İP512	S32T MWLNL 08						1.483,00	
İP514	S40V MWLNL 08						2.030,00	
İP516	S50W MWLNL 08						2.575,00	

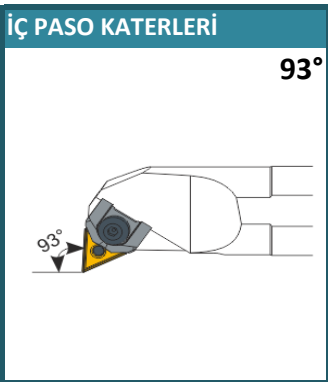

KOD	ÜRÜN AÇIKLAMASI	YEDEKLER				UÇ TİPİ	FİYATI	
İP441	S20R MTUNR 16	*	*	PİM 01	KEP 07	M5x23 TCM 49	TNMG 1604	987,00
İP442	S25S MTUNR 16	TAM 10	PİM 01				KEP 07	M5x23 TCM 49
İP444	S32T MTUNR 16			1.483,00				
İP446	S40V MTUNR 16			2.030,00				
İP450	S32T MTUNR 22	TAM 11	PİM 02	KEP 08	M6x27 TCM 50	TNMG 2204 İSO	1.483,00	
İP452	S40V MTUNR 22						2.030,00	
İP454	S50W MTUNR 22						2.575,00	
İP455	S60W MTUNR 22						3.539,00	

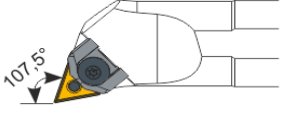

KOD	ÜRÜN AÇIKLAMASI	YEDEKLER				UÇ TİPİ	FİYATI				
İP519	S20R MTUNL 16	*	*	TAM 10	PİM 01	KEP 07	M5x23 TCM 49	TNMG 1604	987,00		
İP520	S25S MTUNL 16	TAM 10	PİM 01					KEP 07	M5x23 TCM 49	TNMG 1604 İSO	1.089,00
İP522	S32T MTUNL 16										1.483,00
İP524	S40V MTUNL 16										2.030,00
İP528	S32T MTUNL 22	TAM 11	PİM 02	KEP 08	M6 TCM 50	TNMG 2204 İSO	1.483,00				
İP530	S40V MTUNL 22						2.030,00				
İP532	S50W MTUNL 22						2.575,00				

İÇ PASO KATERLERİ
107.5°

KOD	ÜRÜN AÇIKLAMASI	YEDEKLER				UÇ TİPİ	FİYATI
İP364	S20R MTQNR 16	*	*			TNMG 1604 İSO	987,00
İP366	S25S MTQNR 16	TAM 10	PİM 01	KEP 07	M5x23 TCM 49		1.089,00
İP367	S32T MTQNR 16						1.483,00
İP368	S40V MTQNR 16						2.030,00
İP369	S32T MTQNR 22	TAM 11	PİM 02	KEP 08	TCM 50	TNMG 2204 İSO	1.483,00
İP369-1	S40V MTQNR 22						2.030,00

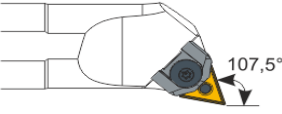
İÇ PASO KATERLERİ
107.5°

KOD	ÜRÜN AÇIKLAMASI	YEDEKLER				UÇ TİPİ	FİYATI
İP537	S20R MTQNL 16	*	*			TNMG 1604 İSO	987,00
İP538	S25S MTQNL 16	TAM 10	PİM 01	KEP 07	M5x23 TCM 49		1.089,00
İP539	S32T MTQNL 16						1.483,00
İP540	S40W MTQNL 16						2.030,00
İP541	S32T MTQNL 22	TAM 11	PİM 02	KEP 08	TCM 50	TNMG 2204 İSO	1.483,00
İP542	S40W MTQNL 22						2.030,00

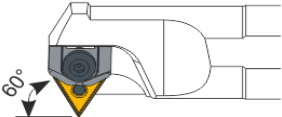
İÇ PASO KATERLERİ
60°

KOD	ÜRÜN AÇIKLAMASI	YEDEKLER				UÇ TİPİ	FİYATI
İP456	S20R MT-NR 16	*	*			TNMG 1604 İSO	987,00
İP457	S25S MT-NR 16	TAM 10	PİM 01	KEP 07	M5x23 TCM 49		1.089,00
İP458	S32T MT-NR 16						1.483,00
İP459	S40V MT-NR 16						2.030,00
İP460	S32T MT-NR 22	TAM 11	PİM 02	KEP 08	TCM 50	TNMG 2204 İSO	1.483,00
İP461	S40V MT-NR 22						2.030,00

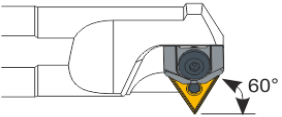
İÇ PASO KATERLERİ
60°

KOD	ÜRÜN AÇIKLAMASI	YEDEKLER				UÇ TİPİ	FİYATI
İP550	S20R MT-NL 16	*	*			TNMG 1604 İSO	987,00
İP552	S25S MT-NL 16	TAM 10	PİM 01	KEP 07	M5x23 TCM 49		1.089,00
İP554	S32T MT-NL 16						1.483,00
İP556	S40V MT-NL 16						2.030,00

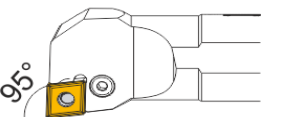

İÇ PASO KATERLERİ -P
95°

KOD	ÜRÜN AÇIKLAMASI	YEDEKLER				UÇ TİPİ	FİYATI
PM100	S25S PCLNR 12	TAM 03	MPV M8 K	MPL 012	MPS 012	CNMG 1204 İSO	1.028,00
PM102	S32T PCLNR 12						1.387,00
PM104	S40V PCLNR 12						2.030,00
PM106	S32T PCLNR 16	TAM 05	MPL 016	MPS 016		CNMG 1606 İSO	1.387,00
PM108	S40V PCLNR 16						2.078,00
PM110	S40V PCLNR 19	TAM 06		MPL 019	MPS 019	CNMG 1906	2.177,00
PM112	S40V PCLNL 12 -SOL					CNMG 1204	2.030,00

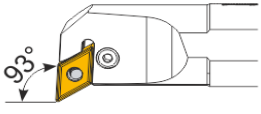

İÇ PASO KATERLERİ -P

93°



KOD	ÜRÜN AÇIKLAMASI	YEDEKLER	UÇ TİPİ	FİYATI
PM114	S25S PDUNR 15	TAM 02 TCM 72 MPL 012 MPS 012	DNMG 1506 İSO	1.028,00
PM116	S32T PDUNR 15			1.387,00
PM118	S40V PDUNR 15			2.030,00



İÇ PASO KATERLERİ -P

95°

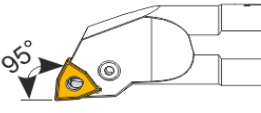

KOD	ÜRÜN AÇIKLAMASI	YEDEKLER	UÇ TİPİ	FİYATI
PM120	S25S PWLNR 08	TAM 12 TCM 72 MPL 012 MPS 012	WNMG 0804 İSO	1.028,00
PM122	S32T PWLNR 08			1.387,00
PM124	S40V PWLNR 08			2.030,00



İÇ PASO KATERLERİ -P

93°

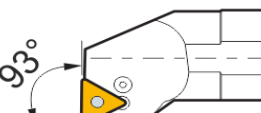

KOD	ÜRÜN AÇIKLAMASI	YEDEKLER	UÇ TİPİ	FİYATI
PM126	S32T PTUNR 22	TAM 11 TCM 72 MPL 012 MPS 012	TNMG 2204 İSO	1.423,00
PM128	S40V PTUNR 22			2.078,00



3" LÜ - İÇ ÇAP SETLERİ

93°



KOD	ÜRÜN AÇIKLAMASI	UÇ TİPİ	FİYATI
SET01	S10-12-16 SDUCR	DCMT 07-11	1.329,00
SET03	S10-12-16 SDUCL	DCMT 07-11	1.329,00
SET05	A10-12-16 SDUCR -IC	DCMT 07-11	1.737,00
SET07	A10-12-16 SDUCL -IC	DCMT 07-11	1.737,00

4" LÜ - İÇ ÇAP SETLERİ

93°



KOD	ÜRÜN AÇIKLAMASI	UÇ TİPİ	FİYATI
SET02	S10-12-16-20 SDUCR	DCMT 07-11	1.874,00
SET04	S10-12-16-20 SDUCL	DCMT 07-11	1.874,00
SET06	A10-12-16-20 SDUCR -IC	DCMT 07-11	2.512,00
SET08	A10-12-16-20 SDUCL -IC	DCMT 07-11	2.512,00

4" LÜ - İÇ ÇAP SETLERİ

95°



KOD	ÜRÜN AÇIKLAMASI	UÇ TİPİ	FİYATI
SET09	S08-10-12-16 SCLCR	CCMT 06-09	1.765,00
SET12	S08-10-12-16 SCLCL	CCMT 06-09	1.765,00
SET15	A08-10-12-16 SCLCR -IC	CCMT 06-09	2.400,00
SET18	A08-10-12-16 SCLCL -IC	CCMT 06-09	2.400,00

5"Li - İÇ ÇAP SETLERİ

95°



KOD	ÜRÜN AÇIKLAMASI	UÇ TİPİ	FİYATI
SET10	S08-10-12-16-20 SCLCR	CCMT 06-09	2.342,00
SET13	S08-10-12-16-20 SCLCL	CCMT 06-09	2.342,00
SET16	A08-10-12-16-20 SCLCR -IC	CCMT 06-09	3.135,00
SET19	A08-10-12-16-20 SCLCL -IC	CCMT 06-09	3.135,00

6"Li - İÇ ÇAP SETLERİ

95°



KOD	ÜRÜN AÇIKLAMASI	UÇ TİPİ	FİYATI
SET11	S06-08-10-12-16-20 SCLCR	CCMT 06-09	2.739,00
SET14	S06-08-10-12-16-20 SCLCL	CCMT 06-09	2.739,00
SET17	A06-08-10-12-16-20 SCLCR -IC	CCMT 06-09	3.710,00
SET20	A06-08-10-12-16-20 SCLCL -IC	CCMT 06-09	3.710,00

İÇ DİŞ KATERLERİ

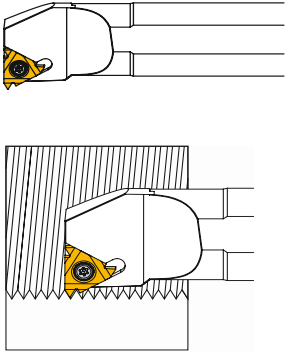

KOD	ÜRÜN AÇIKLAMASI	YEDEKLER	UÇ TİPİ	FİYATI
SIR01	S10K SIR 11	M2.5x6x3.5 TCM 16	11 IR İSO	572,00
SIR02	S12M SIR 11			572,00
SIR03	S16-10Q SIR 11			643,00
SIR04	S16Q SIR 11			643,00
SIR05	S16-13Q SIR 16	M3.5x10x5.3 TCM 34	16 IR İSO	643,00
SIR06	S16Q SIR 16			643,00
SIR07	S20-16Q SIR 16			643,00
SIR08	S20R SIR 16			690,00
SIR09	S25S SIR 16			734,00
SIR10	S32T SIR 16			1.063,00
SIR11	S40V SIR 16			1.609,00

İÇ DİŞ KATERLERİ

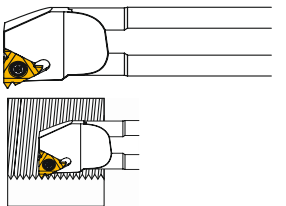

KOD	ÜRÜN AÇIKLAMASI	YEDEKLER	UÇ TİPİ	FİYATI
SIR12	S20R SIR 22	M4.5x17x6,5 TAM 20	22 IR İSO	690,00
SIR13	S25S SIR 22			757,00
SIR14	S32T SIR 22	M4x11x5,3 KEP 13		1.132,00
SIR15	S40T SIR 22			1.657,00
SIR16	S50W SIR 22			2.524,00
SIR17	S60W SIR 22			3.577,00

İÇ DİŞ KATERLERİ

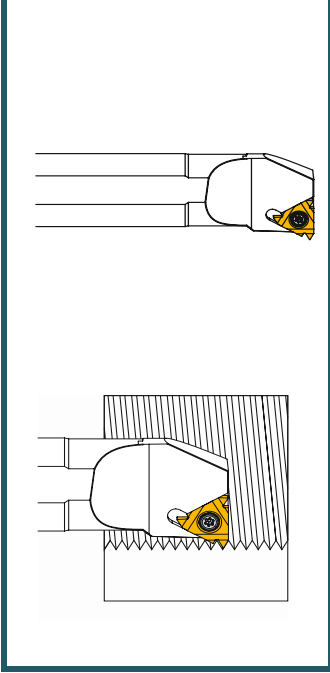

KOD	ÜRÜN AÇIKLAMASI	YEDEKLER	UÇ TİPİ	FİYATI
SIL01	S10K SIL 11	M2.5x6x3.5 TCM 16	11 ER İSO	572,00
SIL02	S12M SIL 11			572,00
SIL03	S16-10Q SIL 11			643,00
SIL04	S16Q SIL 11			643,00
SIL05	S16-13Q SIL 16	M3.5x10x5.3 TCM 34	16 ER İSO	643,00
SIL06	S16Q SIL 16			643,00
SIL08	S20R SIL 16			690,00
SIL09	S25S SIL 16			734,00
SIL10	S32T SIL 16			1.063,00
SIL11	S40V SIL 16			1.609,00
SIL12	S20R SIL 22	M4.5x17x6.5 TCM 89	22 ER İSO	690,00
SIL13	S25S SIL 22			757,00
SIL14	S32T SIL 22			1.132,00
SIL15	S40V SIL 22			1.657,00
SIL16	S50W SIL 22			2.575,00

İÇ DİŞ KATERLERİ



KOD	ÜRÜN AÇIKLAMASI	YEDEKLER	UÇ TİPİ	FİYATI
SIR20	S25S SIR 22 U UTYPE	M4.5x17x6.5 TCM 89	22 U UTYPE ZCC	787,00
SIR21	S32T SIR 22 U UTYPE			1.163,00
SIR22	S40V SIR 22 U UTYPE			1.683,00
SIR23	S32T SIR 27 U UTYPE	M5x15x6.5 TCM 47	27 U UTYPE ZCC	1.214,00
SIR24	S40V SIR 27 U UTYPE			1.757,00

DİŞ DİŞ KATERLERİ

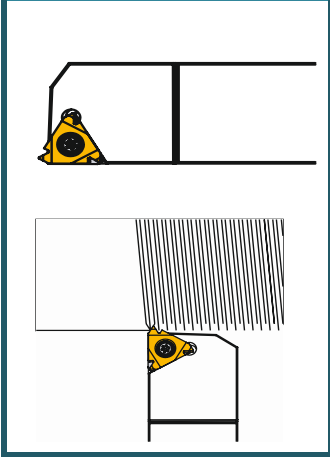

KOD	ÜRÜN AÇIKLAMASI	YEDEKLER	UÇ TİPİ	FİYATI		
SER01	12 x 12 SER H11	M2.5x7x3.5 TCM 18	11 ER İSO	643,00		
SER02	16 x 16 SER H11			667,00		
SER03	12 x 12 SER H16	M3.5x14x5.3 TCM 76	16 ER İSO	643,00		
SER04	16 x 16 SER K16			667,00		
SER05	20 x 20 SER K16			714,00		
SER06	25 x 25 SER M16			798,00		
SER07	32 x 32 SER P16			965,00		
SER07-1	20 x 20 SER K22			M4.5x17x6.5	22 ER İSO	714,00
SER08	25 x 25 SER M22					798,00
SER09	32 x 32 SER P22	965,00				

DİŞ DİŞ KATERLERİ



KOD	ÜRÜN AÇIKLAMASI	YEDEKLER	UÇ TİPİ	FİYATI
SER10	25 x 25 M22 U UTYPE	M4.5x17x6.5 TCM 89	22 U UTYPE ZCC	797,00
SER11	32 x 32 P22 U UTYPE			959,00
SER12	25 x 25 M27 U UTYPE	M5x15x6.5	22 U UTYPE	797,00

DIŞ DIŞ KATERLERİ

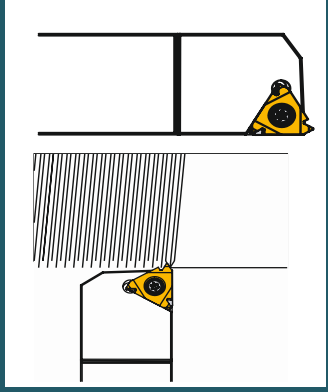

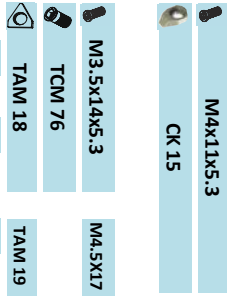
KOD	ÜRÜN AÇIKLAMASI	YEDEKLER	UÇ TİPİ	FİYATI
SEL01	12 x 12 SEL H11	M2.5x7x3.5	11 IR	643,00
SEL02	16 x 16 SEL K11	TCM 18	İSO	667,00
SEL03	12 x 12 SEL H16		16 IR	643,00
SEL04	16 x 16 SEL K16			667,00
SEL05	20 x 20 SEL K16			714,00
SEL06	25 x 25 SEL M16			798,00
SEL07	32 x 32 SEL P16			965,00
SEL08	25 x 25 SEL M22	TAM 19	22 IR	798,00
SEL09	32 x 32 SEL P22	M4.5x17	İSO	965,00

DIŞ TARAĞI



KOD	ÜRÜN AÇIKLAMASI	YEDEKLER	UÇ TİPİ	FİYATI
DT01	16 x W16 L120 DIŞ TARAĞI	M4x9x5.4	CPT C14	1.660,00
DT02	18 x W20 L100 DIŞ TARAĞI	TCM 40	CPT C21	1.660,00
DT03	21 x W25 L120 DIŞ TARAĞI	M4x11x5.3	CPT C21	1.700,00
DT04	25 x W25 L120 DIŞ TARAĞI	TCM 42	CPT C21	1.700,00

DIŞ PASO KATERLERİ

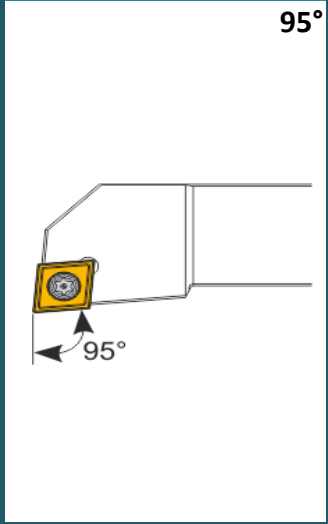

KOD	ÜRÜN AÇIKLAMASI	YEDEKLER	UÇ TİPİ	FİYATI
DP001	SCLCR 08x08 H06	M2.5x7x3.5 TCM 18	CCMT 0602 İSO	572,00
DP002	SCLCR 10x10 H06			572,00
DP003	SCLCR 12x12 H06			572,00
DP004	SCLCR 16x16 H06			643,00
DP005	SCLCR 12x12 H09	M3.5x10x5.3 TCM 34	CCMT 09T3 İSO	572,00
DP006	SCLCR 16x16 H09			643,00
DP007	SCLCR 20x20 J09			690,00
DP008	SCLCR 25x25 M09			734,00
DP009	SCLCR 16x16 H12	M5x12x7 TCM 46	CCMT 1204 İSO	643,00
DP010	SCLCR 20x20 K12	TAM 17 TCM 78 M4x14x7 TCM 45		690,00
DP011	SCLCR 25x25 M12			734,00
DP012	SCLCR 32x32 P12			890,00
				

DIŞ PASO KATERLERİ

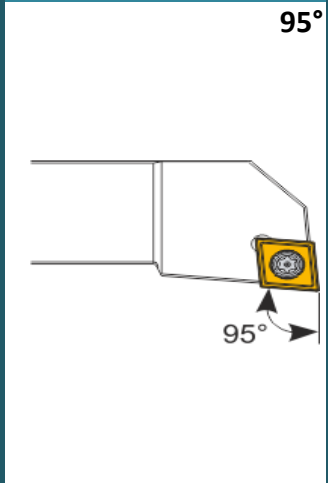

KOD	ÜRÜN AÇIKLAMASI	YEDEKLER	UÇ TİPİ	FİYATI
DP013	SCLCL 08x08 H06	M2.5x7x3.5 TCM 18	CCMT 0602 İSO	572,00
DP014	SCLCL 10x10 H06			572,00
DP015	SCLCL 12x12 H06			572,00
DP016	SCLCL 16x16 H06			643,00
DP018	SCLCL 16x16 H09	M3.5x10x5.3 TCM 34	CCMT 09T3 İSO	643,00
DP019	SCLCL 20x20 K09			690,00
DP020	SCLCL 25x25 M09			734,00
DP021	SCLCL 16x16 H12	M5x12x7 TCM 46	CCMT 1204 İSO	643,00
DP022	SCLCL 20x20 K12	TAM 17 TCM 78 M4x14x7 TCM 45		690,00
DP023	SCLCL 25x25 M12			734,00
DP024	SCLCL 32x32 P12			890,00
				

DIŞ PASO KATERLERİ

50°



KOD	ÜRÜN AÇIKLAMASI	YEDEKLER	UÇ TİPİ	FİYATI
DP025	SCNCN 08x08 H06	M2.5x7x3.5 TCM 18	CCMT 0602 İSO	572,00
DP026	SCNCN 10x10 H06			572,00
DP027	SCNCN 12x12 H06			572,00
DP028	SCNCN 12x12 H09	M3.5x10x5.3 TCM 34	CCMT 09T3 İSO	572,00
DP029	SCNCN 16x16 H09			643,00
DP030	SCNCN 20x20 K09			690,00
DP031	SCNCN 25x25 M12	TAM 17 TCM 78 M4x14x7 TCM 45	CCMT 1204	734,00



DIŞ PASO KATERLERİ

93°

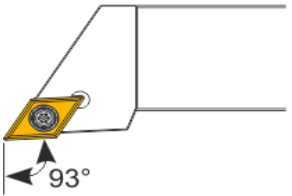

KOD	ÜRÜN AÇIKLAMASI	YEDEKLER	UÇ TİPİ	FİYATI
DP032	SDJCR 08x08 H07	M2.5x7x3.5 TCM 18	DCMT 0702 İSO	572,00
DP033	SDJCR 10x10 H07			572,00
DP034	SDJCR 12x12 H07			572,00
DP035	SDJCR 16x16 H07			643,00
DP036	SDJCR 16x16 H11	TAM 13 TCM 76 3.5x14x5.3 TCM 38	DCMT 11T3 İSO	643,00
DP037	SDJCR 20x20 K11			690,00
DP038	SDJCR 25x25 M11			734,00
DP039	SDJCR 32x32 P11			857,00



DIŞ PASO KATERLERİ

93°

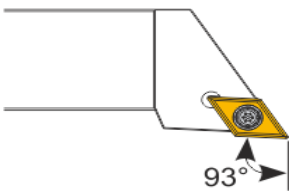

KOD	ÜRÜN AÇIKLAMASI	YEDEKLER	UÇ TİPİ	FİYATI
DP040	SDJCL 08x08 H07	M2.5x7x3.5 TCM 18	DCMT 0702 İSO	572,00
DP041	SDJCL 10x10 H07			572,00
DP042	SDJCL 12x12 H07			572,00
DP043	SDJCL 16x16 H07			643,00
DP043-1	SDJCL 12x12 H11	M3.5x10x5.3 TCM 34	DCMT 11T3 İSO	572,00
DP044	SDJCL 16x16 H11	TAM 13 TCM 76 3.5x14x5.3 TCM 38		643,00
DP045	SDJCL 20x20 K11			690,00
DP046	SDJCL 25x25 M11			734,00
DP047	SDJCL 32x32 P11			857,00



DIŞ PASO KATERLERİ

62.5°

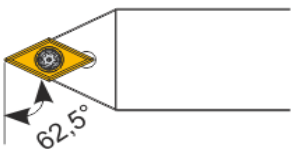

KOD	ÜRÜN AÇIKLAMASI	YEDEKLER	UÇ TİPİ	FİYATI
DP048	SDNCN 08x08 H07	M2.5x7x3.5 TCM 18	DCMT 0702 İSO	572,00
DP049	SDNCN 10x10 H07			572,00
DP050	SDNCN 12x12 H07			572,00
DP051	SDNCN 16x16 H07			643,00
DP053	SDNCN 16x16 H11	TAM 13 TCM 76 3.5x14x5.3 TCM 38	DCMT 11T3 İSO	643,00
DP054	SDNCN 20x20 K11			690,00
DP055	SDNCN 25x25 M11			734,00
DP056	SDNCN 32x32 P11			857,00

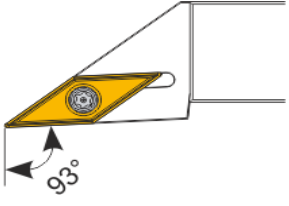

DIŞ PASO KATERLERİ
93°

KOD	ÜRÜN AÇIKLAMASI	YEDEKLER	UÇ TİPİ	FİYATI
DP057	SVJBR 12x12 H11	M2.5x7x3.5 TCM 18	VBMT 1102 İSO	572,00
DP058	SVJBR 16x16 H11			643,00
DP059	SVJBR 20x20 K11			690,00
DP060	SVJBR 25x25 M11			714,00
DP061	SVJBR 16x16 H16	M3.5x10x5.3 TCM 34	VBMT 1604 İSO	690,00
DP062	SVJBR 20x20 K16	TAM 14 TCM 76 M3.5x14 TCM 38		714,00
DP063	SVJBR 25x25 M16			734,00
DP064	SVJBR 32x32 P16			890,00

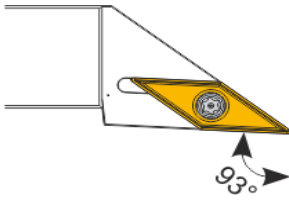
DIŞ PASO KATERLERİ
93°

KOD	ÜRÜN AÇIKLAMASI	YEDEKLER	UÇ TİPİ	FİYATI
DP065	SVJBL 12x12 H11	M2.5x7x3.5 TCM 18	VBMT 1102 İSO	572,00
DP066	SVJBL 16x16 H11			643,00
DP067	SVJBL 20x20 K11			690,00
DP069	SVJBL 16x16 H16	M3.5x10x5.3 TCM 34	VBMT 1604 İSO	690,00
DP070	SVJBL 20x20 K16	TAM 14 TCM 76 M3.5x14 TCM 38		714,00
DP071	SVJBL 25x25 M16			734,00
DP072	SVJBL 32x32 P16			890,00

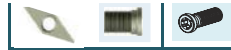
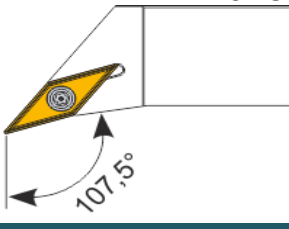
DIŞ PASO KATERLERİ
107.5°

KOD	ÜRÜN AÇIKLAMASI	YEDEKLER	UÇ TİPİ	FİYATI
DP073	SVHBR 12x12 H11	M2.5x7x3.5 TCM 18	VBMT 1102 İSO	572,00
DP074	SVHBR 16x16 H11			643,00
DP075	SVHBR 20x20 K11			690,00
DP076	SVHBR 20x20 K16	TAM 14 TCM 76 M3.5x14 TCM 38	VBMT 1604 İSO	714,00
DP077	SVHBR 25x25 M16			734,00
DP078	SVHBR 32x32 P16			890,00

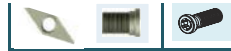
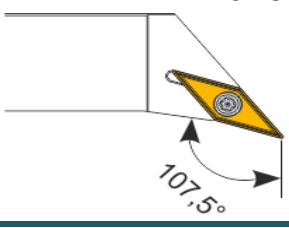
DIŞ PASO KATERLERİ
107.5°

KOD	ÜRÜN AÇIKLAMASI	YEDEKLER	UÇ TİPİ	FİYATI
DP079	SVHBL 12x12 H11	M2.5x7x3.5 TCM 18	VBMT 1102 İSO	572,00
DP080	SVHBL 16x16 H11			643,00
DP081	SVHBL 20x20 K11			690,00
DP082	SVHBL 20x20 K16	TAM 14 TCM 76 M3.5x14 TCM 38	VBMT 1604 İSO	714,00
DP083	SVHBL 25x25 M16			734,00
DP084	SVHBL 32x32 P16			890,00

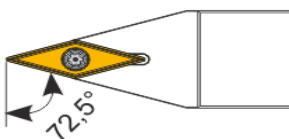

DIŞ PASO KATERLERİ
72.5°

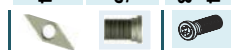
KOD	ÜRÜN AÇIKLAMASI	YEDEKLER	UÇ TİPİ	FİYATI
DP085	SVVBN 12x12 H11	M2.5x7x3.5 TCM 18	VBMT 1102 İSO	572,00
DP086	SVVBN 16x16 H11			643,00
DP087	SVVBN 20x20 K11			690,00
DP088	SVVBN 16x16 H16	M3.5x10x5.3 TCM 34	VBMT 1604 İSO	690,00
DP089	SVVBN 20x20 K16	TAM 14 TCM 76 M3.5x14 TCM 38		714,00
DP090	SVVBN 25x25 M16			734,00
DP091	SVVBN 32x32 P16			890,00

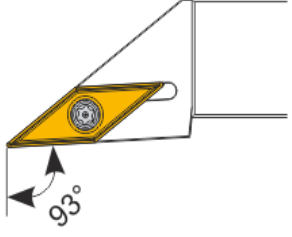

DIŞ PASO KATERLERİ

93°



KOD	ÜRÜN AÇIKLAMASI	YEDEKLER	UÇ TİPİ	FİYATI	
DP092	SVJCR 12x12 H11	M2.5x7x3.5 TCM 18	VCMT 1102 İSO	572,00	
DP093	SVJCR 16x16 H11			643,00	
DP094	SVJCR 20x20 K11			690,00	
DP095	SVJCR 16x16 H16	M3.5x10x5.3 TCM 34	VCMT 1604 İSO	690,00	
DP096	SVJCR 20x20 K16			714,00	
DP097	SVJCR 25x25 M16			734,00	
DP098	SVJCR 32x32 P16			890,00	
		TAM 15	TCM 76	M3.5x14 TCM 38	

DIŞ PASO KATERLERİ

93°

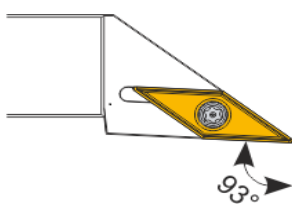

KOD	ÜRÜN AÇIKLAMASI	YEDEKLER	UÇ TİPİ	FİYATI	
DP099	SVJCL 12x12 H11	M2.5x7x3.5 TCM 18	VCMT 1102 İSO	572,00	
DP100	SVJCL 16x16 H11			643,00	
DP101	SVJCL 20x20 K11			690,00	
DP102	SVJCL 16x16 H16	M3.5x10x5.3 TCM 34	VCMT 1604 İSO	690,00	
DP103	SVJCL 20x20 K16			714,00	
DP104	SVJCL 25x25 M16			734,00	
DP105	SVJCL 32x32 P16			890,00	
		TAM 15	TCM 76	M3.5x14 TCM 38	

DIŞ PASO KATERLERİ

72.5°

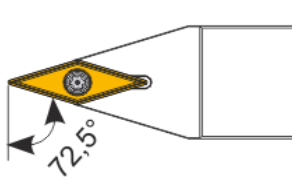

KOD	ÜRÜN AÇIKLAMASI	YEDEKLER	UÇ TİPİ	FİYATI	
DP106	SVVCN 12x12 H11	M2.5x7x3.5 TCM 18	VCMT 1102 İSO	572,00	
DP107	SVVCN 16x16 H11			572,00	
DP108	SVVCN 20x20 K11			690,00	
DP109	SVVCN 16x16 H16	M3.5x10x5.3 TCM 34	VCMT 1604 İSO	690,00	
DP110	SVVCN 20x20 K16			714,00	
DP111	SVVCN 25x25 M16			734,00	
DP112	SVVCN 32x32 P16			890,00	
		TAM 15	TCM 76	M3.5x14 TCM 38	

DIŞ PASO KATERLERİ

90°

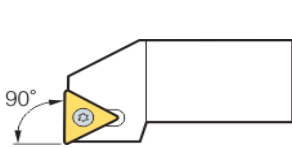

KOD	ÜRÜN AÇIKLAMASI	YEDEKLER	UÇ TİPİ	FİYATI	
DP113	STFCR 12x12 H11	M2.5x7x3.5 TCM 18	TCMT 1102 İSO	572,00	
DP114	STFCR 16x16 H11			643,00	
DP115	STFCR 16x16 H16	M3.5x10x5.3 TCM 34	TCMT 16T3 İSO	650,00	
DP116	STFCR 20x20 K16			690,00	
DP117	STFCR 25x25 M16			734,00	
		TAM 16	TCM 76	M3.5x10 TCM 34	

DIŞ PASO KATERLERİ

90°

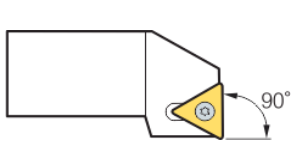

KOD	ÜRÜN AÇIKLAMASI	YEDEKLER	UÇ TİPİ	FİYATI	
DP118	STFCL 12x12 H11	M2.5x7x3.5 TCM 18	TCMT 1102 İSO	572,00	
DP119	STFCL 16x16 H11			643,00	
DP120	STFCL 16x16 H16	M3.5x10x5.3 TCM 34	TCMT 16T3 İSO	650,00	
DP121	STFCL 20x20 K16			690,00	
DP122	STFCL 25x25 M16			734,00	
		TAM 16	TCM 76	TCM 34	

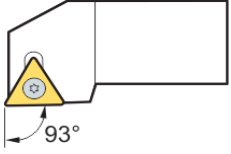
DIŞ PASO KATERLERİ
93°

KOD	ÜRÜN AÇIKLAMASI	YEDEKLER	UÇ TİPİ	FİYATI
DP123	STJCR 16x16 H16	M3.5x10x5.3 TCM 34	TCMT 16T3 İSO	650,00
DP124	STJCR 20x20 K16	TAM 16		690,00
DP125	STJCR 25x25 M16	TCM 76 TCM 34		734,00

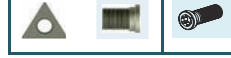
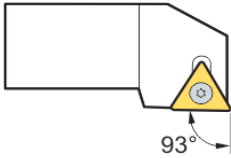
DIŞ PASO KATERLERİ
93°

KOD	ÜRÜN AÇIKLAMASI	YEDEKLER	UÇ TİPİ	FİYATI
DP127	STJCL 20x20 K16	TAM 16	TCMT 16T3 İSO	690,00
DP128	STJCL 25x25 M16	TCM 76 TCM 34		734,00

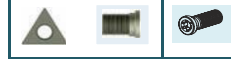
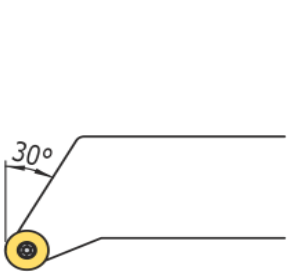
DIŞ PASO KATERLERİ
30°

KOD	ÜRÜN AÇIKLAMASI	YEDEKLER	UÇ TİPİ	FİYATI
DP129	SRGCR 16x16 H08	M3x8x4.2 TCM 29	RCMT 0803 İSO	643,00
DP130	SRGCR 20x20 K08			690,00
DP131	SRGCR 25x25 M08			734,00
DP132	SRGCR 16x16 H10	M4x11x5.3 TCM 42	RCMT 10T3 İSO	643,00
DP133	SRGCR 20x20 K10			690,00
DP134	SRGCR 25x25 M10			734,00
DP135	SRGCR 32x32 P10		890,00	
DP136	SRGCR 16x16 H12		RCMT 1204 İSO	643,00
DP137	SRGCR 20x20 K12	690,00		
DP138	SRGCR 25x25 M12	734,00		
DP139	SRGCR 32x32 P12	890,00		

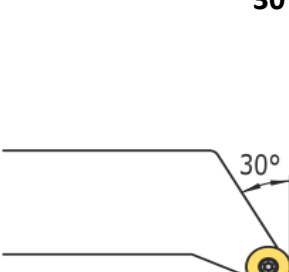
DIŞ PASO KATERLERİ
30°

KOD	ÜRÜN AÇIKLAMASI	YEDEKLER	UÇ TİPİ	FİYATI
DP140	SRGCL 16x16 H08	M3x8x4.2 TCM 29	RCMT 0803 İSO	643,00
DP141	SRGCL 20x20 K08			690,00
DP142	SRGCL 25x25 M08			734,00
DP143	SRGCL 16x16 H10	M4x11x5.3 TCM 42	RCMT 10T3 İSO	643,00
DP144	SRGCL 20x20 K10			690,00
DP145	SRGCL 25x25 M10			734,00
DP146	SRGCL 32x32 P10		890,00	
DP147	SRGCL 16x16 H12	RCMT 1204 İSO	643,00	
DP148	SRGCL 20x20 K12		690,00	
DP149	SRGCL 25x25 M12		734,00	
DP150	SRGCL 32x32 P12		890,00	

DIŞ PASO KATERLERİ

21°

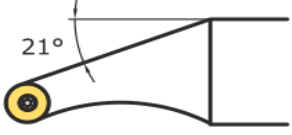

KOD	ÜRÜN AÇIKLAMASI	YEDEKLER	UÇ TİPİ	FİYATI
DP151	SRHCR 16x16 H08	M3x8x4.2 TCM 29	RCMT 0803 İSO	643,00
DP152	SRHCR 20x20 K08			690,00
DP153	SRHCR 25x25 M08			734,00
DP154	SRHCR 20x20 K10	M4x11x5.3 TCM 42	RCMT 10T3 İSO	690,00
DP155	SRHCR 25x25 M10			734,00
DP156	SRHCR 16x16 H12		RCMT 1204 İSO	643,00
DP157	SRHCR 20x20 K12			690,00
DP158	SRHCR 25x25 M12			734,00
DP159	SRHCR 32x32 P12	890,00		

DIŞ PASO KATERLERİ

21°

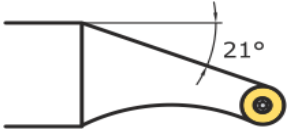

KOD	ÜRÜN AÇIKLAMASI	YEDEKLER	UÇ TİPİ	FİYATI
DP160	SRHCL 20x20 K08	M3x8x4.2 TCM 29	RCMT 0803 İSO	690,00
DP161	SRHCL 25x25 M08			734,00
DP162	SRHCL 20x20 K10	M4x11x5.3 TCM 42	RCMT 10T3 İSO	690,00
DP163	SRHCL 25x25 M10			734,00
DP164	SRHCL 20x20 K12		RCMT 1204 İSO	690,00
DP165	SRHCL 25x25 M12			734,00

DIŞ PASO KATERLERİ

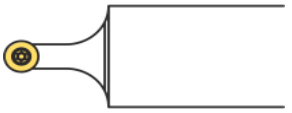

KOD	ÜRÜN AÇIKLAMASI	YEDEKLER	UÇ TİPİ	FİYATI
DP166	SRDCN 16x16 H08	M3x8x4.2 TCM 29	RCMT 0803 İSO	643,00
DP167	SRDCN 20x20 K08			690,00
DP168	SRDCN 25x25 M08			734,00
DP169	SRDCN 16x16 H10	M4x11x5.3 TCM 42	RCMT 10T3 İSO	643,00
DP170	SRDCN 20x20 K10			690,00
DP171	SRDCN 25x25 M10			734,00
DP172	SRDCN 32x32 P10		890,00	
DP173	SRDCN 20x20 K12		RCMT 1204 İSO	690,00
DP174	SRDCN 25x25 M12	734,00		
DP175	SRDCN 32x32 P12	890,00		
DP176	SRDCN 25x25 M16	M5x15x6.5 TCM 47	RCMT 1604	734,00
DP176-1	SRDCN 32x32 P16			890,00

DIŞ PASO KATERLERİ

93°

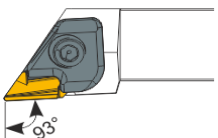

KOD	ÜRÜN AÇIKLAMASI	YEDEKLER	UÇ TİPİ	FİYATI
DP177	CKJNR 20x20 K16-R (SAÇ KEP)	TAM 21 TCM 58 KEP 09 M6x27 TCM 50	KNUX 1604-R İSO	734,00
DP178	CKJNR 25x25 M16-R			774,00
DP179	CKJNR 32x32 P16-R			1.089,00
DP180	CKJNR 40x40 R16-R			1.808,00



DIŞ PASO KATERLERİ

93°

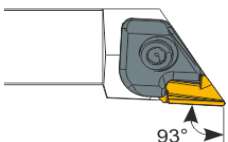

KOD	ÜRÜN AÇIKLAMASI	YEDEKLER	UÇ TİPİ	FİYATI
DP181	CKJNL 20x20 K16-L (SAÇ KEP)	TAM 22 TCM 58 KEP 10 M6x27 TCM 50	KNUX 1604-L İSO	734,00
DP182	CKJNL 25x25 M16-L			774,00
DP183	CKJNL 32x32 P16-L			1.089,00
DP184	CKJNL 40x40 R16-L			1.808,00



DIŞ PASO KATERLERİ
90°

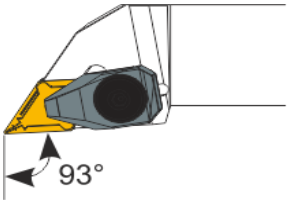

KOD	ÜRÜN AÇIKLAMASI	YEDEKLER				UÇ TİPİ	FİYATI
DP185	CTGPR 16x16 H11	***		KEP 17	M6x17X7,5	TPKN 1103	714,00
DP186	CTGPR 16x16 H16	TAM 23	TCM 60	KEP 18		TPKN 1603 İSO	714,00
DP187	CTGPR 20x20 K16						734,00
DP188	CTGPR 25x25 M16						774,00
DP189	CTGPR 25x25 M22						774,00

DIŞ PASO KATERLERİ
93°

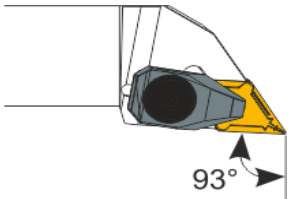
KOD	ÜRÜN AÇIKLAMASI	YEDEKLER				UÇ TİPİ	FİYATI
DP190	TDJNR 16x16 K11	TAM 01	TCM 60	KEP 01	TCM 49	DNMG 1104 İSO	774,00
DP191	TDJNR 20x20 K11						880,00
DP192	TDJNR 25x25 M11						923,00
DP193	TDJNR 16x16 K15	TAM 02	TCM 60	KEP 02	TCM 50	DNMG 1506 İSO	774,00
DP194	TDJNR 20x20 K15						880,00
DP195	TDJNR 25x25 M15						923,00
DP196	TDJNR 32x32 P15						1.132,00
DP197	TDJNR 40x40 R15						1.808,00

DIŞ PASO KATERLERİ
93°

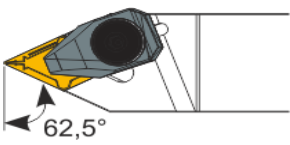
KOD	ÜRÜN AÇIKLAMASI	YEDEKLER				UÇ TİPİ	FİYATI
DP198	TDJNL 16x16 K11	TAM 01	TCM 60	KEP 01	TCM 49	DNMG 1104 İSO	774,00
DP199	TDJNL 20x20 K11						880,00
DP200	TDJNL 25x25 M11						923,00
DP202	TDJNL 20x20 K15	TAM 02	TCM 60	KEP 02	TCM 50	DNMG 1506 İSO	880,00
DP203	TDJNL 25x25 M15						923,00
DP204	TDJNL 32x32 P15						1.132,00
DP205	TDJNL 40x40 R15						1.808,00

DIŞ PASO KATERLERİ
62.5°

KOD	ÜRÜN AÇIKLAMASI	YEDEKLER				UÇ TİPİ	FİYATI
DP206	TDNNN 16x16 H11	TAM 01	TCM 60	KEP 01	TCM 49	DNMG 1104 İSO	774,00
DP207	TDNNN 20x20 K11						880,00
DP208	TDNNN 25x25 M11						923,00
DP209	TDNNN 20x20 K15	TAM 02	TCM 60	KEP 02	TCM 50	DNMG 1506 İSO	880,00
DP210	TDNNN 25x25 M15						923,00
DP211	TDNNN 32x32 P15						1.132,00
DP212	TDNNN 40x40 R15						1.808,00

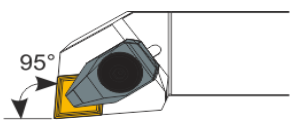

DIŞ PASO KATERLERİ
95°

KOD	ÜRÜN AÇIKLAMASI	YEDEKLER				UÇ TİPİ	FİYATI
DP213	TCLNR 16x16 H12	TAM 03	TCM 60	KEP 02	TCM 50	CNMG 1204 İSO	774,00
DP214	TCLNR 20x20 K12						880,00
DP215	TCLNR 25x25 M12						923,00
DP216	TCLNR 32x32 P12						1.222,00
DP217	TCLNR 25x25 M16	TAM 05	TCM 62	KEP 03	TCM 51	CNMG 1606 İSO	1.089,00
DP218	TCLNR 32x32 P16						1.222,00
DP219	TCLNR 40x40 R16						1.955,00
DP220	TCLNR 32x32 P19	TAM 06	TCM 62	KEP 04	TCM 51	CNMG 1906 İSO	1.394,00
DP221	TCLNR 40x40 R19						1.955,00

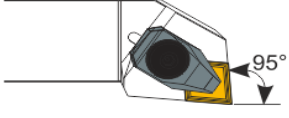

DIŞ PASO KATERLERİ

95°



KOD	ÜRÜN AÇIKLAMASI	YEDEKLER				UÇ TİPİ	FİYATI
DP222	TCLNL 16x16 H12	TAM 03	TCM 60	KEP 02	TCM 50	CNMG 1204 İSO	774,00
DP223	TCLNL 20x20 K12						880,00
DP224	TCLNL 25x25 M12						923,00
DP225	TCLNL 32x32 P12						1.222,00
DP226	TCLNL 25x25 M16	TAM 05	TCM 62	KEP 03	TCM 50	CNMG 1606 İSO	1.089,00
DP227	TCLNL 32x32 P16						1.222,00
DP228	TCLNL 40x40 R16						1.955,00
DP229	TCLNL 32x32 P19	TAM 06	TCM 62	KEP 04	TCM 51	CNMG 1906 İSO	1.394,00
DP230	TCLNL 40x40 R19						1.955,00



DIŞ PASO KATERLERİ

75°

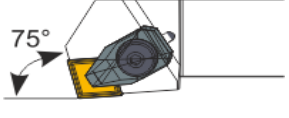

KOD	ÜRÜN AÇIKLAMASI	YEDEKLER				UÇ TİPİ	FİYATI
DP231	TCKNR 25x25 M12	TAM 03	TCM 60	KEP 02	TCM 50	CNMG 1204	923,00
DP232	TCKNR 25x25 M16	TAM 05	TCM 62	KEP 03		CNMG 1606 İSO	923,00
DP233	TCKNR 32x32 P16				1.132,00		



DIŞ PASO KATERLERİ

75°

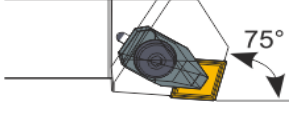

KOD	ÜRÜN AÇIKLAMASI	YEDEKLER				UÇ TİPİ	FİYATI
DP234	TCKNL 25x25 M12	TAM 03	TCM 60	KEP 02	TCM 50	CNMG 1204	923,00
DP235	TCKNL 25x25 M16	TAM 05	TCM 62	KEP 03		CNMG 1606 İSO	923,00
DP236	TCKNL 32x32 P16				1.132,00		



DIŞ PASO KATERLERİ

75°

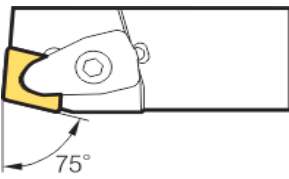

KOD	ÜRÜN AÇIKLAMASI	YEDEKLER				UÇ TİPİ	FİYATI
DP237	TCBNR 20x20 K12	TAM 03	TCM 60	KEP 02	TCM 50	CNMG 1204 İSO	880,00
DP238	TCBNR 25x25 M12						923,00
DP239	TCBNR 32x32 P12						1.132,00
DP240	TCBNR 32x32 P16	TAM 05	TCM 62	KEP 03	TCM 51	CNMG 1606	1.222,00
DP241	TCBNR 32x32 P19	TCM 06	TCM 62	KEP 04		CNMG 1906 İSO	1.222,00
DP242	TCBNR 40x40 R19				2.004,00		



DIŞ PASO KATERLERİ

75°

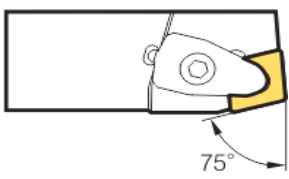

KOD	ÜRÜN AÇIKLAMASI	YEDEKLER				UÇ TİPİ	FİYATI
DP243	TCBNL 20x20 K12	TAM 03	TCM 60	KEP 02	TCM 50	CNMG 1204 İSO	880,00
DP244	TCBNL 25x25 M12						923,00
DP245	TCBNL 32x32 P12						1.132,00
DP246	TCBNL 32x32 P16	TAM 05	TCM 62	KEP 03	TCM 51	CNMG 1606	1.222,00
DP247	TCBNL 32x32 P19	TCM 06	TCM 62	KEP 04		CNMG 1906 İSO	1.222,00
DP248	TCBNL 40x40 R19				2.004,00		

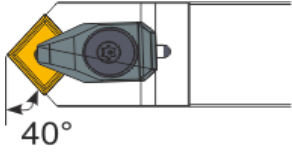

DIŞ PASO KATERLERİ
40°

KOD	ÜRÜN AÇIKLAMASI	YEDEKLER				UÇ TİPİ	FİYATI
DP249	TCMNN 20x20 K12	TAM 03	TCM 60	KEP 02	TCM 50	CNMG 1204 İSO	880,00
DP250	TCMNN 25x25 M12						923,00
DP251	TCMNN 32x32 P12						1.132,00
DP252	TCMNN 32x32 P16	TAM 05	TCM 62	KEP 03	TCM 51	CNMG 1606	1.394,00
DP253	TCMNN 32x32 P19	TAM 06					1.394,00
DP254	TCMNN 40x40 R19			KEP 04		CNMG 1906 İSO	1.955,00

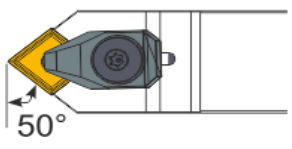
DIŞ PASO KATERLERİ
50°

KOD	ÜRÜN AÇIKLAMASI	YEDEKLER				UÇ TİPİ	FİYATI
DP255	TCZNN 20x20 K12	TAM 03	TCM 60	KEP 02	TCM 50	CNMG 1204 İSO	880,00
DP256	TCZNN 25x25 M12						923,00
DP257	TCZNN 32x32 P12						1.132,00
DP258	TCZNN 32x32 P16	TAM 05	TCM 62	KEP 03	TCM 51	CNMG 1606	1.222,00
DP259	TCZNN 32x32 P19	TAM 06					1.394,00
DP260	TCZNN 40x40 R19			KEP 04		CNMG 1906 İSO	1.808,00

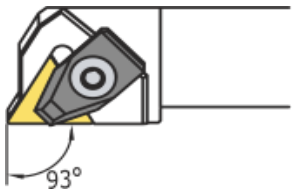
DIŞ PASO KATERLERİ
93°

KOD	ÜRÜN AÇIKLAMASI	YEDEKLER				UÇ TİPİ	FİYATI
DP261	TTJNR 16x16 H16	TAM 24	TCM 60	KEP 01	TCM 49	TNMG 1604 İSO	774,00
DP262	TTJNR 20x20 K16						880,00
DP263	TTJNR 25x25 M16						923,00
DP264	TTJNR 20x20 K22	TAM 25	TCM 60	KEP 02	TCM 50	TNMG 2204 İSO	923,00
DP265	TTJNR 25x25 M22						1.008,00
DP266	TTJNR 32x32 P22						1.138,00
DP267	TTJNR 40x40 R22						1.808,00

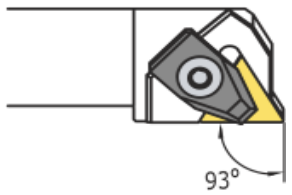
DIŞ PASO KATERLERİ
93°

KOD	ÜRÜN AÇIKLAMASI	YEDEKLER				UÇ TİPİ	FİYATI
DP268	TTJNL 16x16 H16	TAM 24	TCM 60	KEP 01	TCM 49	TNMG 1604 İSO	774,00
DP269	TTJNL 20x20 K16						880,00
DP270	TTJNL 25x25 M16						923,00
DP271	TTJNL 20x20 K22	TAM 25	TCM 60	KEP 02	TCM 50	TNMG 2204 İSO	923,00
DP272	TTJNL 25x25 M22						1.008,00
DP273	TTJNL 32x32 P22						1.138,00
DP274	TTJNL 40x40 R22						1.808,00

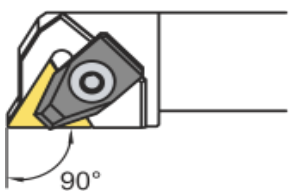

DIŞ PASO KATERLERİ
90°

KOD	ÜRÜN AÇIKLAMASI	YEDEKLER				UÇ TİPİ	FİYATI
DP275	TTGNR 20x20 K16	TAM 24	TCM 60	KEP 01	TCM 49	TNMG 1604 İSO	880,00
DP276	TTGNR 25x25 M16						923,00
DP277	TTGNR 20x20 K22	TAM 25	TCM 60	KEP 02	TCM 50	TNMG 2204 İSO	923,00
DP278	TTGNR 25x25 M22						1.008,00
DP279	TTGNR 32x32 P22						1.138,00
DP280	TTGNR 40x40 R22						1.808,00

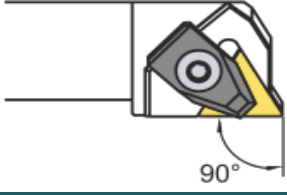

DIŞ PASO KATERLERİ

90°



KOD	ÜRÜN AÇIKLAMASI	YEDEKLER				UÇ TİPİ	FİYATI
DP282	TTGNL 20x20 K16	TAM 24	TCM 60	KEP 01	TCM 49	TNMG 1604	880,00
DP283	TTGNL 25x25 M16					İSO	923,00
DP284	TTGNL 20x20 K22	TAM 25	TCM 60	KEP 02	TCM 50	TNMG 2204	923,00
DP285	TTGNL 25x25 M22					İSO	1.008,00
DP286	TTGNL 32x32 P22					İSO	1.138,00
DP287	TTGNL 40x40 R22					İSO	1.808,00



DIŞ PASO KATERLERİ

95°

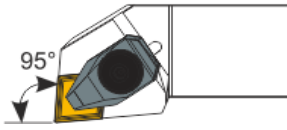

KOD	ÜRÜN AÇIKLAMASI	YEDEKLER				UÇ TİPİ	FİYATI
DP288	TSLNR 20x20 K12	TAM 07	TCM 60	KEP 02	TCM 50	TNMG 1204	880,00
DP289	TSLNR 25x25 M12					İSO	923,00
DP290	TSLNR 32x32 P12					İSO	1.132,00
DP291	TSLNR 32x32 P15	TAM 08	TCM 62	KEP 03	TCM 51	TNMG 1506	1.163,00
DP292	TSLNR 40x40 R15					İSO	1.955,00
DP293	TSLNR 32x32 P19	TAM 09	TCM 62	KEP 04	TCM 51	TNMG 1906	1.222,00
DP294	TSLNR 40x40 R19					İSO	1.955,00



DIŞ PASO KATERLERİ

95°

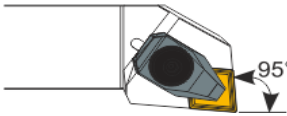

KOD	ÜRÜN AÇIKLAMASI	YEDEKLER				UÇ TİPİ	FİYATI
DP295	TSLNL 20x20 K12	TAM 07	TCM 60	KEP 02	TCM 50	TNMG 1204	880,00
DP296	TSLNL 25x25 M12					İSO	923,00
DP297	TSLNL 32x32 P12					İSO	1.132,00
DP298	TSLNL 32x32 P15	TAM 08	TCM 62	KEP 03	TCM 51	TNMG 1506	1.163,00
DP299	TSLNL 40x40 R15					İSO	1.955,00
DP300	TSLNL 32x32 P19	TAM 09	TCM 62	KEP 04	TCM 51	TNMG 1906	1.222,00
DP301	TSLNL 40x40 R19					İSO	1.955,00



DIŞ PASO KATERLERİ

75°

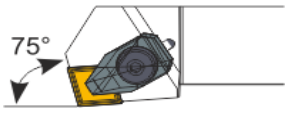

KOD	ÜRÜN AÇIKLAMASI	YEDEKLER				UÇ TİPİ	FİYATI
DP302	TSKNR 20x20 K12	TAM 07	TCM 60	KEP 02	TCM 50	TNMG 1204	880,00
DP303	TSKNR 25x25 M12					İSO	923,00
DP304	TSKNR 32x32 P15	TAM 08	TCM 62	KEP 03	TCM 51	TNMG 1506	1.163,00
DP305	TSKNR 40x40 R19	TAM 09	TCM 62	KEP 04	TCM 51	TNMG 1906	1.955,00



DIŞ PASO KATERLERİ

75°

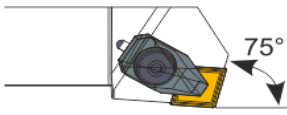

KOD	ÜRÜN AÇIKLAMASI	YEDEKLER				UÇ TİPİ	FİYATI
DP306	TSKNL 20x20 K12	TAM 07	TCM 60	KEP 02	TCM 50	TNMG 1204	880,00
DP307	TSKNL 25x25 M12					İSO	923,00
DP308	TSKNL 32x32 P15	TAM 08	TCM 62	KEP 03	TCM 51	TNMG 1506	1.163,00
DP309	TSKNL 40x40 R19	TAM 09	TCM 62	KEP 04	TCM 51	TNMG 1906	1.955,00



DIŞ PASO KATERLERİ
15°

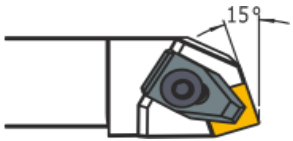

KOD	ÜRÜN AÇIKLAMASI	YEDEKLER				UÇ TİPİ	FİYATI
DP310	TSRNR 20x20 K12	TAM 07	TCM 60	KEP 02	TCM 50	SNMG 1204 İSO	880,00
DP311	TSRNR 25x25 M12						923,00
DP312	TSRNR 32x32 P12						1.132,00
DP313	TSRNR 32x32 P15	TAM 08	TCM 62	KEP 03	TCM 51	SNMG 1506 İSO	1.163,00
DP314	TSRNR 40x40 R15						1.955,00
DP315	TSRNR 32x32 P19	TAM 09	TCM 62	KEP 04	TCM 51	SNMG 1906 İSO	1.222,00
DP316	TSRNR 40x40 R19						1.955,00

DIŞ PASO KATERLERİ
15°

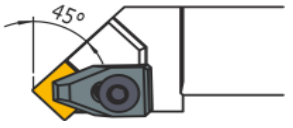
KOD	ÜRÜN AÇIKLAMASI	YEDEKLER				UÇ TİPİ	FİYATI
DP317	TSRNL 20x20 K12	TAM 07	TCM 60	KEP 02	TCM 50	SNMG 1204 İSO	880,00
DP318	TSRNL 25x25 M12						923,00
DP319	TSRNL 32x32 P12						1.132,00
DP320	TSRNL 32x32 P15	TAM 08	TCM 62	KEP 03	TCM 51	SNMG 1506 İSO	1.163,00
DP321	TSRNL 40x40 R15						1.955,00
DP322	TSRNL 32x32 P19	TAM 09	TCM 62	KEP 04	TCM 51	SNMG 1906 İSO	1.222,00
DP323	TSRNL 40x40 R19						1.955,00

DIŞ PASO KATERLERİ
45°

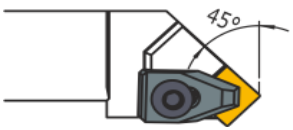
KOD	ÜRÜN AÇIKLAMASI	YEDEKLER				UÇ TİPİ	FİYATI
DP324	TSSNR 20x20 K12	TAM 07	TCM 60	KEP 02	TCM 50	SNMG 1204 İSO	880,00
DP325	TSSNR 25x25 M12						923,00
DP326	TSSNR 32x32 P12						1.132,00
DP327	TSSNR 32x32 P15	TAM 08	TCM 62	KEP 03	TCM 51	SNMG 1506	1.163,00
DP328	TSSNR 32x32 P19						1.222,00
DP329	TSSNR 40x40 R19	TAM 09	TCM 62	KEP 04	TCM 51	SNMG 1906 İSO	1.955,00

DIŞ PASO KATERLERİ
45°

KOD	ÜRÜN AÇIKLAMASI	YEDEKLER				UÇ TİPİ	FİYATI
DP330	TSSNL 20x20 K12	TAM 07	TCM 60	KEP 02	TCM 50	SNMG 1204 İSO	880,00
DP331	TSSNL 25x25 M12						923,00
DP332	TSSNL 32x32 P12						1.132,00
DP333	TSSNL 32x32 P15	TAM 08	TCM 62	KEP 03	TCM 51	SNMG 1506	1.163,00
DP334	TSSNL 32x32 P19						1.222,00
DP335	TSSNL 40x40 R19	TAM 09	TCM 62	KEP 04	TCM 51	SNMG 1906 İSO	1.955,00

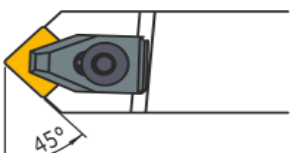

DIŞ PASO KATERLERİ
45°

KOD	ÜRÜN AÇIKLAMASI	YEDEKLER				UÇ TİPİ	FİYATI
DP336	TSDNN 20x20 K12	TAM 07	TCM 60	KEP 02	TCM 50	SNMG 1204 İSO	880,00
DP337	TSDNN 25x25 M12						923,00
DP338	TSDNN 32x32 P12						1.132,00
DP339	TSDNN 32x32 P15	TAM 08	TCM 62	KEP 03	TCM 51	SNMG 1506 İSO	1.163,00
DP340	TSDNN 40x40 R15						1.955,00
DP341	TSDNN 32x32 P19	TAM 09	TCM 62	KEP 04	TCM 51	SNMG 1906 İSO	1.222,00
DP342	TSDNN 40x40 R19						1.955,00

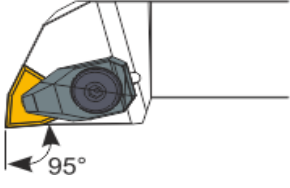

DIŞ PASO KATERLERİ

95°



KOD	ÜRÜN AÇIKLAMASI	YEDEKLER				UÇ TİPİ	FİYATI
DP343	TWLNR 16x16 K06	**	KEP 01	TCM 49	WNMG 0604 İSO	774,00	
DP344	TWLNR 20x20 K06					880,00	
DP345	TWLNR 25x25 M06					923,00	
DP346	TWLNR 20x20 K08	TAM 12	TCM 60	KEP 02	TCM 50	880,00	
DP347	TWLNR 25x25 M08					923,00	
DP348	TWLNR 32x32 P08					1.132,00	
DP349	TWLNR 40x40 R08					1.808,00	



DIŞ PASO KATERLERİ

95°

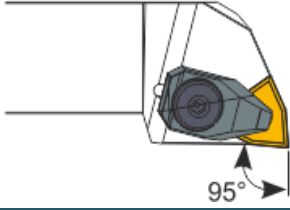

KOD	ÜRÜN AÇIKLAMASI	YEDEKLER				UÇ TİPİ	FİYATI
DP350	TWLNL 16x16 K06	**	KEP 01	TCM 49	WNMG 0604 İSO	774,00	
DP351	TWLNL 20x20 K06					880,00	
DP352	TWLNL 25x25 M06					923,00	
DP353	TWLNL 20x20 K08	TAM 12	TCM 60	KEP 02	TCM 50	880,00	
DP354	TWLNL 25x25 M08					923,00	
DP355	TWLNL 32x32 P08					1.132,00	
DP356	TWLNL 40x40 R08					1.808,00	



DIŞ PASO KATERLERİ

93°

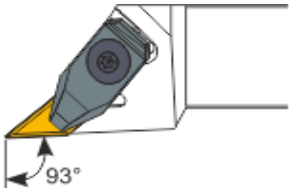

KOD	ÜRÜN AÇIKLAMASI	YEDEKLER				UÇ TİPİ	FİYATI
DP357	TVJNR 16x16 K16	TAM 04	TCM 41	KEP 19	TCM 50	774,00	
DP357-1	TVJNR 20x20 K16					880,00	
DP358	TVJNR 25x25 M16					923,00	
DP358-1	TVJNR 32x32 P16					1.132,00	
DP359	TVJNR 40x40 R16					1.808,00	



DIŞ PASO KATERLERİ

93°

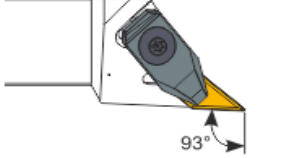

KOD	ÜRÜN AÇIKLAMASI	YEDEKLER				UÇ TİPİ	FİYATI
DP359-1	TVJNL 16x16 K16	TAM 04	TCM 41	KEP 19	TCM 50	774,00	
DP360	TVJNL 20x20 K16					880,00	
DP360-1	TVJNL 25x25 M16					923,00	
DP361	TVJNL 32x32 P16					1.132,00	



DIŞ PASO KATERLERİ

72.5°

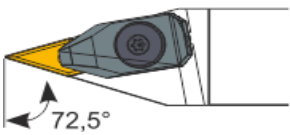

KOD	ÜRÜN AÇIKLAMASI	YEDEKLER				UÇ TİPİ	FİYATI
DP362	TVNNN 20x20 K16	TAM 04	TCM 41	KEP 19	TCM 50	880,00	
DP363	TVNNN 25x25 M16					923,00	
DP364	TVNNN 32x32 P16					1.132,00	
DP365	TVNNN 40x40 R16					1.808,00	



DIŞ PASO KATERLERİ

95°

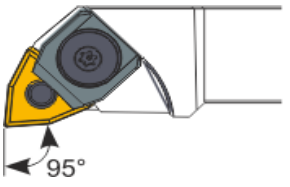

KOD	ÜRÜN AÇIKLAMASI	YEDEKLER				UÇ TİPİ	FİYATI
DP366	MWLNR 16x16 K06	**	PJM 01	KEP 05	TCM 49	774,00	
DP367	MWLNR 20x20 K06					880,00	
DP368	MWLNR 25x25 M06					923,00	
DP369	MWLNR 20x20 K08	TAM 12	PJM 02	KEP 06	TCM 50	880,00	
DP370	MWLNR 25x25 M08					923,00	
DP371	MWLNR 32x32 P08					1.132,00	
DP372	MWLNR 40x40 R08					1.829,00	

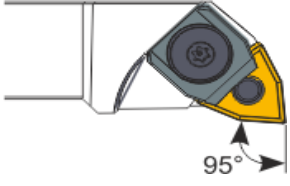

DIŞ PASO KATERLERİ
95°

KOD	ÜRÜN AÇIKLAMASI	YEDEKLER			UÇ TİPİ	FİYATI	
DP373	MWLNL 16x16 K06	**	PIM 01	KEP 05	TCM 49	WNMG 0604 İSO	774,00
DP374	MWLNL 20x20 K06						880,00
DP375	MWLNL 25x25 M06						923,00
DP376	MWLNL 20x20 K08	TAM 12	PIM 02	KEP 06	TCM 50	WNMG 0804 İSO	880,00
DP377	MWLNL 25x25 M08						923,00
DP378	WWLNL 32x32 P08						1.132,00
DP379	WWLNL 40x40 R08						1.829,00

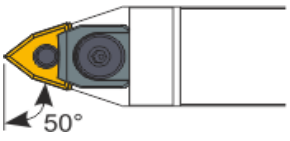
DIŞ PASO KATERLERİ
50°

KOD	ÜRÜN AÇIKLAMASI	YEDEKLER			UÇ TİPİ	FİYATI	
DP380	MWDNN 16x16 H06	**	PIM 01	KEP 05	TCM 49	WNMG 0604 İSO	774,00
DP381	MWDNN 20x20 K06						880,00
DP382	MWDNN 20x20 K08	TAM 12	PIM 02	KEP 06	TCM 50	WNMG 0804 İSO	880,00
DP383	MWDNN 25x25 M08						923,00
DP384	MWDNN 32x32 P08						1.132,00
DP385	MWDNN 40x40 R08						1.829,00

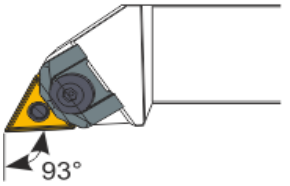
DIŞ PASO KATERLERİ
93°

KOD	ÜRÜN AÇIKLAMASI	YEDEKLER			UÇ TİPİ	FİYATI	
DP386	MTJNR 16x16 K16	TAM 10	PIM 01	KEP 07	TCM 49	TNMG 1604 İSO	774,00
DP387	MTJNR 20x20 K16						880,00
DP388	MTJNR 25x25 M16						923,00
DP389	MTJNR 32x32 P16						1.132,00
DP390	MTJNR 25x25 M22	TAM 11	PIM 02	KEP 08	TCM 50	TNMG 2204 İSO	923,00
DP391	MTJNR 32x32 P22						1.163,00
DP392	MTJNR 40x40 R22						1.808,00

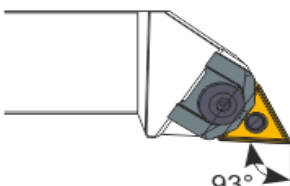
DIŞ PASO KATERLERİ
93°

KOD	ÜRÜN AÇIKLAMASI	YEDEKLER			UÇ TİPİ	FİYATI	
DP393	MTJNL 16x16 K16	TAM 10	PIM 01	KEP 07	TCM 49	TNMG 1604 İSO	774,00
DP394	MTJNL 20x20 K16						880,00
DP395	MTJNL 25x25 M16						923,00
DP396	MTJNL 32x32 P16						1.089,00
DP397	MTJNL 25x25 M22	TAM 11	PIM 02	KEP 08	TCM 50	TNMG 2204 İSO	923,00
DP398	MTJNL 32x32 P22						1.163,00
DP399	MTJNL 40x40 R22						1.808,00

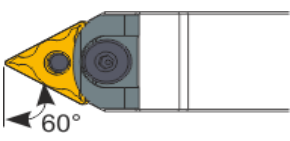

DIŞ PASO KATERLERİ
60°

KOD	ÜRÜN AÇIKLAMASI	YEDEKLER			UÇ TİPİ	FİYATI	
DP400	MTENN 16x16 K16	TAM 10	PIM 01	KEP 07	TCM 49	TNMG 1604 İSO	774,00
DP401	MTENN 20x20 K16						880,00
DP402	MTENN 25x25 M16						923,00
DP403	MTENN 32x32 P16						1.132,00
DP404	MTENN 25x25 M22	TAM 11	PIM 02	KEP 08	TCM 50	TNMG 2204 İSO	923,00
DP405	MTENN 32x32 P22						1.163,00
DP406	MTENN 40x40 R22						1.808,00

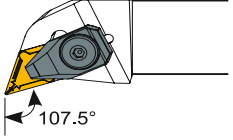

DIŞ PASO KATERLERİ

107.5°



KOD	ÜRÜN AÇIKLAMASI	YEDEKLER				UÇ TİPİ	FİYATI
DP500	TDHNR 20x20 K15	TAM 02	TCM 60	KEP 02	TCM 50	DNMG 1506 İSO	880,00
DP501	TDHNR 25x25 M15						923,00
DP502	TDHNR 32x32 P15						1.132,00

DIŞ PASO KATERLERİ

107.5°

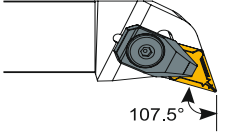

KOD	ÜRÜN AÇIKLAMASI	YEDEKLER				UÇ TİPİ	FİYATI
DP503	TDHNL 20x20 K15	TAM 02	TCM 60	KEP 02	TCM 50	DNMG 1506 İSO	880,00
DP504	TDHNL 25x25 M15						923,00
DP505	TDHNL 32x32 P15						1.132,00

DIŞ PASO KATERLERİ -P

93°

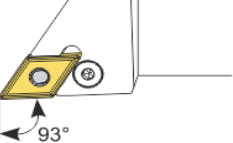

KOD	ÜRÜN AÇIKLAMASI	YEDEKLER				UÇ TİPİ	FİYATI
DP407	PDJNR 20x20 K15	TAM 02	TCM 74	MPL 012	MPS 012	DNMG 1506 İSO	880,00
DP408	PDJNR 25x25 M15						923,00
DP409	PDJNR 32x32 P15						1.262,00
DP410	PDJNR 40x40 R15						1.829,00

DIŞ PASO KATERLERİ -P

93°



KOD	ÜRÜN AÇIKLAMASI	YEDEKLER				UÇ TİPİ	FİYATI
DP411	PDJNL 20x20 K15	TAM 02	TCM 74	MPL 012	MPS 012	DNMG 1506 İSO	880,00
DP412	PDJNL 25x25 M15						923,00
DP413	PDJNL 32x32 P15						1.262,00
DP414	PDJNL 40x40 R15						1.829,00

DIŞ PASO KATERLERİ -P

62.5°

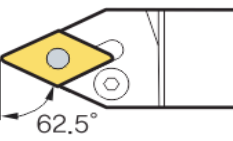

KOD	ÜRÜN AÇIKLAMASI	YEDEKLER				UÇ TİPİ	FİYATI
DP415	PDNNN 20x20 K15	TAM 02	TCM 74	MPL 012	MPS 012	DNMG 1506 İSO	880,00
DP416	PDNNN 25x25 M15						923,00
DP417	PDNNN 32x32 P15						1.262,00
DP418	PDNNN 40x40 R15						1.829,00

DIŞ PASO KATERLERİ -P

95°

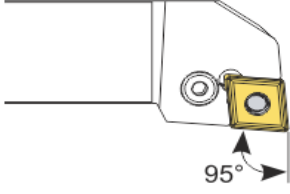

KOD	ÜRÜN AÇIKLAMASI	YEDEKLER				UÇ TİPİ	FİYATI
DP419	PCLNR 20x20 K12	TAM 03	TCM 74	MPL 012	MPS 012	CNMG 1204 İSO	880,00
DP420	PCLNR 25x25 M12						923,00
DP421	PCLNR 32x32 P12						1.163,00
DP422	PCLNR 40x40 R12						1.955,00
DP423	PCLNR 25x25 M16	TAM 05	TCM 74	MPL 016	MPS 016	CNMG 1606 İSO	1.072,00
DP424	PCLNR 32x32 P16						1.305,00
DP425	PCLNR 40x40 R16						1.955,00
DP426	PCLNR 32x32 P19	TAM 06	TCM 74	MPL 019	MPS 019	CNMG 1906 İSO	1.305,00
DP427	PCLNR 40x40 R19						2.004,00

DIŞ PASO KATERLERİ -P
95°

KOD	ÜRÜN AÇIKLAMASI	YEDEKLER				UÇ TİPİ	FİYATI
DP428	PCLNL 20x20 K12	TAM 03	TCM 74	MPL012	MPS 012	CNMG 1204 İSO	880,00
DP429	PCLNL 25x25 M12						923,00
DP430	PCLNL 32x32 P12						1.163,00
DP431	PCLNL 40x40 R12						1.955,00
DP432	PCLNL 25x25 M16	TAM 05	TCM 74	MPL 16	MPS 016	CNMG 1606 İSO	1.072,00
DP433	PCLNL 32x32 P16						1.305,00
DP435	PCLNL 32x32 P19	TAM 06	TCM 74	MPL 19	MPS 019	CNMG 1906	1.305,00

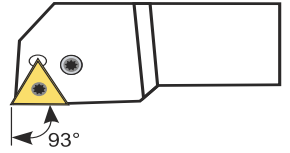
DIŞ PASO KATERLERİ -P
93°

KOD	ÜRÜN AÇIKLAMASI	YEDEKLER				UÇ TİPİ	FİYATI
DP442	PTJNR 25x25 M22	TAM 11	TCM 74	MPL 012	MPS 012	TNMG 2204 İSO	1.008,00
DP443	PTJNR 32x32 P22						1.305,00
DP450	PTJNL 25x25 M22	TAM 11	TCM 74	MPL 012	MPS 012	TNMG 2204 İSO	1.008,00
DP453	PTJNL 32x32 P22						1.305,00

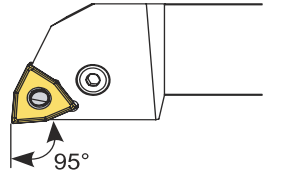
DIŞ PASO KATERLERİ -P
95°

KOD	ÜRÜN AÇIKLAMASI	YEDEKLER				UÇ TİPİ	FİYATI
DP454	PWLNR 20x20 K08	TAM 12	TCM 74	MPL 012	MPS 012	WNMG 0804 İSO	880,00
DP455	PWLNR 25x25 M08						923,00
DP456	PWLNR 32x32 P08						1.132,00
DP457	PWLNR 40x40 R08						1.829,00

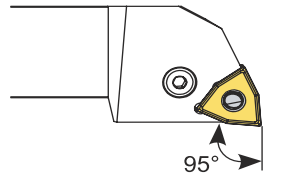
DIŞ PASO KATERLERİ -P
95°

KOD	ÜRÜN AÇIKLAMASI	YEDEKLER				UÇ TİPİ	FİYATI
DP458	PWLNL 20x20 K08	TAM 12	TCM 74	MPL 012	MPS 012	WNMG 0804 İSO	880,00
DP459	PWLNL 25x25 M08						923,00
DP460	PWLNL 32x32 P08						1.132,00
DP461	PWLNL 40x40 R08						1.829,00

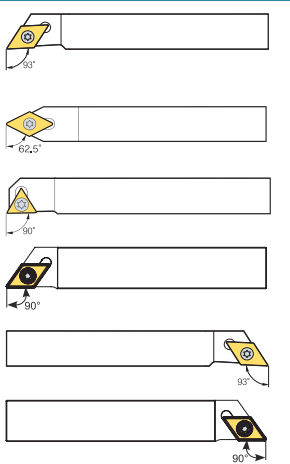
KAYAR OTOMAT KATERLERİ

KOD	ÜRÜN AÇIKLAMASI	YEDEKLER				UÇ TİPİ	FİYATI
DP470	SDJCR 12x12 K11 K.OTOMAT	M3.5x10x5.3 TCM 34	TCM 34	MPL 012	MPS 012	DCMT 11T3 İSO	672,00
DP471	SDJCR 16x16 K11 K.OTOMAT						672,00
DP473	SDNCN 12x12 K11 K.OTOMAT						672,00
DP474	STACR 12x12 K11 K.OTOMAT	M2.5x7x3.5	TCM 18			TCMT 1102	572,00
DP472	SDACR 12x12 K11 K.OTOMAT	M3.5x10x5.3	TCM 34			DCMT 11T3	672,00
DP475	SDJCL 12x12 K11 K.OTOMAT	M3.5x10x5.3 TCM 34	TCM 34	MPL 012	MPS 012	DCMT 11T3 İSO	672,00
DP476	SDJCL 16x16 K11 K.OTOMAT						672,00
DP477	SDACL 12x12 K11 K.OTOMAT						672,00

CNC PUNTA KATERLERİ



KOD	ÜRÜN AÇIKLAMASI	YEDEKLER	UÇ TİPİ	FİYATI
PK01	20x20 CNC PUNTA KATERİ	M5x8 SETSKUR	2,5x6,3	1.039,00
PK02	25x25 CNC PUNTA KATERİ		PUNTA	1.115,00
PK03	20x20 CNC PUNTA KATERİ		3,15x8,0	1.039,00
PK04	25x25 CNC PUNTA KATERİ		PUNTA	1.115,00
PK05	20x20 CNC PUNTA KATERİ	M5x6	4x10	1.039,00
PK06	25x25 CNC PUNTA KATERİ	SETSKUR	PUNTA	1.115,00

HSS KARE KALEM KATERLERİ



KOD	ÜRÜN AÇIKLAMASI	UÇ TİPİ	FİYATI
TK01	06X08 HSS PASO KATERİ	HSS KARE KALEM	768,00
TK02	08X10 HSS PASO KATERİ	HSS KARE KALEM	768,00
TK03	10X12 HSS PASO KATERİ	HSS KARE KALEM	768,00
TK04	12X14 HSS PASO KATERİ	HSS KARE KALEM	768,00

HSS TRAPEZ KALEM KATERLERİ



KOD	ÜRÜN AÇIKLAMASI	UÇ TİPİ	FİYATI
TK05	1/2 HSS KESME LAMA KATERİ	12mm HSS KALEM	768,00
TK06	5/8 HSS KESME LAMA KATERİ	16mm HSS KALEM	768,00
TK07	3/4 HSS KESME LAMA KATERİ	20mm HSS KALEM	768,00
TK08	7/8 HSS KESME LAMA KATERİ	22mm HSS KALEM	850,00
TK09	1" HSS KESME LAMA KATERİ	25mm HSS KALEM	850,00

TEKLİ TIRTIL KATERLERİ





KOD	ÜRÜN AÇIKLAMASI	FİYATI
TK11	CNC 20x20 L125 k10-p6x20	850,00
TK12	CNC 25x25 L150 k10-p6x25	978,00
TK13	16x16 L125 k4 - p4x16	768,00
TK14	16x16 L125 k6 - p6x16	768,00
TK15	16x16 L125 k8 - p6x16	768,00
TK16	20x20 L125 k8 - p6x20	894,00
TK17	25x25 L150 k8 - p6x25	1.023,00
TK18	16x16 L125 k10 - p6x16	768,00
TK19	20x20 L125 k10 - p6x20	894,00
TK20	25x25 L150 k10 - p6x25	1.023,00

ÇİFTLİ TIRTIL KATERLERİ



KOD	ÜRÜN AÇIKLAMASI	FİYATI
TK21	22x22 L150 k10 - p6x25	1.105,00

TARAMA BAŞLIKLARI
90°

KOD	ÜRÜN AÇIKLAMASI	YEDEKLER	UÇ TİPİ	FİYATI
TB010	050 x 3 -22	 M6x075 TCM 56	TPKN 1603 iso	1.275,00
TB011	063 x 4 -22			1.532,00
TB012	080 x 5 -32			1.829,00
TB013	100 x 6 -32			2.044,00
TB014	063 x 3 -22	 M8x1 TCM 57	TPKN 2204 iso	1.532,00
TB015	080 x 4 -32			1.872,00
TB016	100 x 5 -32			2.297,00
TB017-1	125 x 6 -32			3.458,00
TB017	125 x 6 -40			3.458,00
TB018	160 x 7 -40			4.043,00
TB019	200 x 8 -60			6.890,00
TB020	250 x10 -60			9.527,00



TARAMA BAŞLIKLARI
75°

KOD	ÜRÜN AÇIKLAMASI	YEDEKLER	UÇ TİPİ	FİYATI
TB021	063 x 5-22	 M8x1.25(L) TCM 55	SPKN 1203 iso	2.213,00
TB022	080 x 6-27			2.512,00
TB023	100 x 8-32			3.360,00
TB024	125 x10-40			4.212,00
TB025	160 x12-40			5.102,00
TB026	200 x12-60			6.582,00
TB027	125 x10-40		SPKN 1504	4.212,00

TARAMA BAŞLIKLARI
45°







KOD	ÜRÜN AÇIKLAMASI	YEDEKLER	UÇ TİPİ	FİYATI
TB028	063 x 5-22	 M8x1.25(L) TCM 55	SEKR 1204	1.829,00
TB029	100 x 8-32		iso	2.640,00

TARAMA BAŞLIKLARI

KOD	ÜRÜN AÇIKLAMASI	YEDEKLER	UÇ TİPİ	FİYATI
TB030	040 x 4-16	 M3.5x10x5.3 TCM 34	RDKW 1003 iso	1.153,00
TB031	050 x 5-22			1.363,00
TB032	063 x 6-22			1.787,00
TB033	080 x 7-27			2.085,00
TB034	100 x 7-32			2.297,00
TB035	040 x 4-16	 M3.5x8x5.3 TCM 33 KEP 12	RDKW 12T3 iso	1.153,00
TB036	050 x 5-22			1.363,00
TB037	063 x 6-22			1.787,00
TB038	080 x 7-27			2.085,00
TB039	100 x 8-32			2.297,00
TB039-1	125 x 9-40			3.543,00
TB039-2	160 x10-40			4.595,00

TARAMA BAŞLIKLARI



KOD	ÜRÜN AÇIKLAMASI	YEDEKLER	UÇ TİPİ	FİYATI
TB040	040 x 4-16	   M3.5x10x5.3 TCM 34 KEP 12 M3.5x8x5.3 TCM 33	RDKW 1204 iso	1.153,00
TB041	050 x 5-22			1.363,00
TB042	063 x 6-22			1.787,00
TB043	080 x 7-27			2.085,00
TB044	100 x 8-32			2.297,00
TB045	050 x 4-22	   M4.5x7x6.5 KEP 13 M4x11x5.3 TCM 42	RDKW 1604 iso	1.363,00
TB046	052 x 4-22			1.363,00
TB047	063 x 4-22			1.787,00
TB048	066 x 5-27			1.787,00
TB049	080 x 5-27			2.085,00
TB050	100 x 6-32			2.297,00
TB051	125 x 7-40			3.543,00
TB052	160 x 8-40			3.829,00



TARAMA BAŞLIKLARI



KOD	ÜRÜN AÇIKLAMASI	YEDEKLER	UÇ TİPİ	FİYATI
TB055	040 x 4-16	   M3.5x8x5.3 TCM 33	RPMW 1003 iso	1.233,00
TB056	050 x 5-22			1.449,00
TB057	063 x 6-22			1.618,00
TB058	080 x 7-27			2.127,00

TARAMA BAŞLIKLARI



KOD	ÜRÜN AÇIKLAMASI	YEDEKLER	UÇ TİPİ	FİYATI
TB059	040 x 4-16	   RPMW 1204 iso	RPMW 1204 iso	1.233,00
TB060	050 x 5-22			1.532,00
TB061	052 x 5-22			1.532,00
TB062	063 x 6-22			1.787,00
TB063	080 x 7-27			2.170,00

TARAMA BAŞLIKLARI

45°



KOD	ÜRÜN AÇIKLAMASI	YEDEKLER	UÇ TİPİ	FİYATI
TB064	050 x 5-22	 M4x11x5.3 TCM 42	ONMU 0504 iso	1.660,00
TB065	063 x 6-22			2.044,00
TB066	080 x 7-27			2.382,00
TB067	100 x 8-32			3.104,00
TB068	125 x 9-40			4.212,00

TARAMA BAŞLIKLARI



KOD	ÜRÜN AÇIKLAMASI	YEDEKLER	UÇ TİPİ	FİYATI
TB070	052 x 4-22	 M4x9x5.4 TCM 40	SDMT 1204 iso	1.752,00
TB071	066 x 5-22			2.008,00
TB072	080 x 6-27			2.512,00

TARAMA BAŞLIKLARI
90°

KOD	ÜRÜN AÇIKLAMASI	YEDEKLER	UÇ TİPİ	FİYATI
TB073	040 x 5-16	M2.5x7x3.5 TCM 18	APKT 1003 iso	1.064,00
TB074	050 x 6-22			1.403,00
TB075	063 x 7-22			1.618,00
TB076	080 x 8-27			1.872,00
TB077	100 x 9-32			2.213,00
TB078	040 x 4-16	M3.5x10x5.3 TCM 34	APKT 1604 iso	1.064,00
TB079	050 x 4-22			1.363,00
TB080	050 x 5-22			1.363,00
TB081	063 x 5-22			1.575,00
TB082	080 x 6-27			1.917,00
TB083	080 x 7-27			1.917,00
TB084	100 x 8-32			2.213,00
TB085	125 x 9-40			3.488,00
TB086	160 x10-40			4.252,00
TB087	200 x12-60			7.230,00
TB088	250 x14-60	9.780,00		

TARAMA BAŞLIKLARI
75°

KOD	ÜRÜN AÇIKLAMASI	YEDEKLER	UÇ TİPİ	FİYATI
TB089	063 x 6-22 F75T	M2.5x7x3.5 TCM 18	APKT 1003	1.660,00
TB090	063 x 4-22 F75T	M3.5x10x5.3 TCM 34	APKT 1604 iso	1.532,00
TB091	080 x 5-27 F75T			1.872,00
TB092	100 x 6-32 F75T			2.255,00
TB093	125 x 7-40 F75T			3.360,00
TB094	160 x 8-40 F75T			5.102,00

TARAMA BAŞLIKLARI
90°

KOD	ÜRÜN AÇIKLAMASI	YEDEKLER	UÇ TİPİ	FİYATI
TB095	050 x 3-22		VCGT 2205 iso	1.403,00
TB096	063 x 4-22			1.917,00
TB097	080 x 5-27			2.085,00

TARAMA BAŞLIKLARI
45°

KOD	ÜRÜN AÇIKLAMASI	YEDEKLER	UÇ TİPİ	FİYATI
TB098	063 x 5-22	  	OFMT 0706 ISO	2.255,00
TB099	080 x 6-27			2.512,00
TB100	100 x 7-32			3.488,00
TB101	125 x 8-40			4.212,00

TARAMA BAŞLIKLARI
45°

KOD	ÜRÜN AÇIKLAMASI	YEDEKLER	UÇ TİPİ	FİYATI
TB103	063 x 5-22		ONGX 0606 ISO	2.044,00
TB104	080 x 6-27			2.340,00
TB105	100 x 8-32			2.978,00
TB107	160 x10-40			5.102,00

TARAMA BAŞLIKLARI



KOD	ÜRÜN AÇIKLAMASI	YEDEKLER	UÇ TİPİ	FİYATI
TB108	040 x 4-16		RCKT 1204 İSO	1.233,00
TB109	050 x 5-22			1.403,00
TB110	063 x 6-22			1.787,00
TB111	080 x 7-32			2.085,00
TB114	080 x 5-27		RCKT 1606	2.127,00

TARAMA BAŞLIKLARI

90°



KOD	ÜRÜN AÇIKLAMASI	YEDEKLER	UÇ TİPİ	FİYATI
TB115	040 x 5-16		LOMU 1004 KYCR	2.025,00
TB116	050 x 5-22			2.381,00
TB117	050 x 6-22			2.436,00
TB118	063 x 7-22			2.696,00
TB119	080 x 8-27			3.012,00
TB120	050 x 4-22		LOMU 1505 KYCR	1.810,00
TB122	063 x 5-22			2.228,00
TB124	160 x12-40			6.328,00
TB125	200 x14-60			10.255,00

TARAMA BAŞLIKLARI

90°

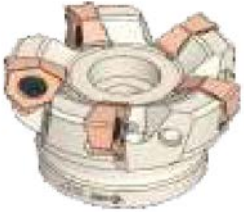

KOD	ÜRÜN AÇIKLAMASI	YEDEKLER	UÇ TİPİ	FİYATI
TB126	040 x 4-16		WNMU 0504 KYCR	1.810,00
TB127	050 x 5-22			1.994,00
TB128	050 x 4-22		M5x15x6.5 TCM 47 WNMU 0806 KYCR	1.768,00
TB129	052 x 4-22			1.817,00
TB131	063 x 5-22			2.211,00
TB134	080 x 6-27			2.564,00
TB135	100 x 7-32			3.096,00
TB136	125 x 8-40			3.981,00
TB138	160 x10-40			5.305,00
TB139	200 x12-60			7.519,00

TARAMA BAŞLIKLARI

45°



KOD	ÜRÜN AÇIKLAMASI	YEDEKLER	UÇ TİPİ	FİYATI
TB141	050 x 4-22		PNMU 1205 KYCR	1.682,00
TB142	063 x 5-22			1.901,00
TB143	080 x 5-27			2.301,00
TB144	100 x 8-32			3.759,00
TB145	125 x10-40			4.335,00
TB146	160 x12-60			5.305,00
TB148	250 x14-60			10.171,00

TARAMA BAŞLIKLARI



KOD	ÜRÜN AÇIKLAMASI	YEDEKLER	UÇ TİPİ	FİYATI
TB149	050 x 5-22	M4x9x5.4 TCM 40	SOMT 1004 KYCR	1.817,00
TB150	052 x 5-22			1.817,00
TB152	052 x 4-22		SOMT 1404 KYCR	1.835,00
TB153	063 x 5-22			2.037,00
TB154	080 x 6-27			2.489,00

TARAMA BAŞLIKLARI

KOD	ÜRÜN AÇIKLAMASI	YEDEKLER	UÇ TİPİ	FİYATI
TB155	040 x 6-16	M3x8x4 TCM 28	LOGU 0303 KYCR	2.168,00
TB156	050 x 7-22			2.206,00
TB157	052 x 6-22			2.295,00

TARAMA BAŞLIKLARI

90°

KOD	ÜRÜN AÇIKLAMASI	YEDEKLER	UÇ TİPİ	FİYATI
TB158	040 x 5-16		BDMT 11T3 KYCR	1.626,00
TB159	050 x 6-22			1.855,00
TB160	040 x 4-16		BDMT 1704 KYCR	1.176,00
TB163	080 x 6-27			1.960,00

TARAMA BAŞLIKLARI

KOD	ÜRÜN AÇIKLAMASI	YEDEKLER	UÇ TİPİ	FİYATI
TB165	040 x 5-16	M3.5x11x4.8 TCM 35	RPMT 10T3 KYCR	1.326,00
TB166	050 x 6-22			1.592,00
TB167	040 x 4-16	M4x11x5.3 TCM 42	RPMT 1204 KYCR	1.281,00
TB168	052 x 5-22			1.592,00
TB169	063 x 6-22			1.901,00

TARAMA BAŞLIKLARI

90°

KOD	ÜRÜN AÇIKLAMASI	YEDEKLER	UÇ TİPİ	FİYATI
TB173	040 x 4-16	M4x11x5.3 TCM 42	ADKT 1505 ISCR	1.203,00
TB174	050 x 5-22			1.449,00
TB175	063 x 6-22			1.700,00
TB176	080 x 7-27			2.213,00
TB177	100 x 8-32			2.617,00

TARAMA BAŞLIKLARI

90°

KOD	ÜRÜN AÇIKLAMASI	YEDEKLER	UÇ TİPİ	FİYATI
TB178	050 x 6-22	M2.5x7x3.5 TCM 18	LNMT 0804 ISCR	1.492,00
TB179	063 x 7-22			1.787,00

TARAMA BAŞLIKLARI

90°

KOD	ÜRÜN AÇIKLAMASI	YEDEKLER	UÇ TİPİ	FİYATI
TB180	040 x 5-16		TPKT 1003 ISCR	1.917,00
TB181	050 x 6-22			2.297,00
TB182	063 x 7-22			2.512,00

TARAMA BAŞLIKLARI

90°

KOD	ÜRÜN AÇIKLAMASI	YEDEKLER	UÇ TİPİ	FİYATI
TB183	050 x 4-22		TDKT 1505 ISCR	1.787,00
TB184	063 x 5-22			2.085,00



KOD	ÜRÜN AÇIKLAMASI	YEDEKLER	UÇ TİPİ	FİYATI
TB185	050 x 5-22	M4x11x5.3 TCM 42	ANKX 1205 ISCR	1.488,00
TB186	063 x 6-22			1.650,00
TB187	080 x 7-27			2.097,00
TB188	100 x 8-32			2.617,00
TB189	125 x10-40			3.530,00



KOD	ÜRÜN AÇIKLAMASI	YEDEKLER	UÇ TİPİ	FİYATI
TB195	050 x 4-22		SNMU 1305 ISCR	1.787,00
TB196	063 x 6-22			2.213,00
TB197	080 x 7-27			2.512,00
TB198	100 x 8-32			2.978,00
TB199	125 x 9-40			3.784,00



KOD	ÜRÜN AÇIKLAMASI	YEDEKLER	UÇ TİPİ	FİYATI
TB200	040 x 3-16	M4.5x12x6.5 TCM 87	ONMU 0505 ISCR	1.449,00
TB201	050 x 4-22			1.787,00
TB202	063 x 6-22			2.213,00
TB203	080 x 7-27			2.512,00
TB204	100 x 8-32			2.978,00
TB205	125 x 9-40			3.784,00

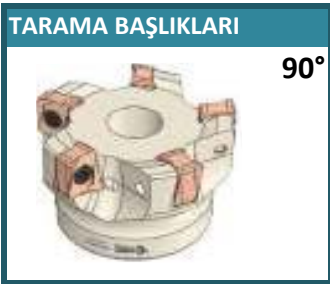

KOD	ÜRÜN AÇIKLAMASI	YEDEKLER	UÇ TİPİ	FİYATI
TB209	050 x 4-22	M4x14x5.3 TCM 43	LNGX 1307 WLTR	1.575,00
TB210	063 x 5-22			1.787,00
TB212	080 x 7-27			2.213,00
TB213	100 x 8-32			2.893,00
TB214	125 x 7-40			3.829,00
TB215	160 x 8-40			5.102,00

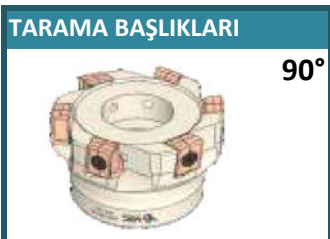

KOD	ÜRÜN AÇIKLAMASI	YEDEKLER	UÇ TİPİ	FİYATI
TB216	040 x 4-16		LNHU 1306 WLTR	1.575,00
TB217	050 x 5-22			1.820,00
TB218	063 x 6-22			1.950,00
TB219	080 x 7-27			2.259,00
TB220	100 x 9-32			2.935,00



KOD	ÜRÜN AÇIKLAMASI	YEDEKLER	UÇ TİPİ	FİYATI
TB221	040 x 4-16	M3x8x4.2 TCM 29	ADMT 1204 WLTR	1.660,00
TB222	050 x 5-22			1.958,00
TB223	063 x 6-22			2.213,00

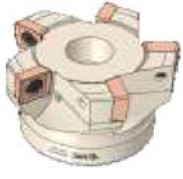

KOD	ÜRÜN AÇIKLAMASI	YEDEKLER	UÇ TİPİ	FİYATI
TB224	040 x 4-16		P 2840 WLTR	1.275,00
TB225	050 x 5-22			1.492,00

TARAMA BAŞLIKLARI

90°

KOD	ÜRÜN AÇIKLAMASI	YEDEKLER	UÇ TİPİ	FİYATI
TB226	050 x 4-22	M4.5x12x6.5 TCM 87	SPMT 1204	1.449,00
TB227	063 x 5-22		WLTR	1.660,00

TARAMA BAŞLIKLARI

KOD	ÜRÜN AÇIKLAMASI	YEDEKLER	UÇ TİPİ	FİYATI
TB232	040 x 6-16	M3x8x4.2 TCM 29	LNMX 0603 KRLY	1.787,00
TB233	050 x 7-22			2.085,00
TB233-1	052 x 7-22			2.085,00
TB234	063 x 8-22			2.425,00
TB235	080 x10-27			2.809,00
TB236	040 x 4-16		LNMX 1006 KRLY	1.275,00
TB236-1	040 x 5-16			1.317,00
TB237	050 x 6-22			1.449,00
TB238	050 x 4-22		LNMX 1510 KRLY	1.532,00
TB239	063 x 6-22			1.917,00
TB240	080 x 7-27			2.127,00
TB241	100 x 8-32			2.550,00
TB242	125 x10-40			3.404,00
TB243	160 x12-40			4.810,00

TARAMA BAŞLIKLARI

KOD	ÜRÜN AÇIKLAMASI	YEDEKLER	UÇ TİPİ	FİYATI
TB244	040 x 6-16		LNMT 0603 KRLY	1.787,00
TB245	052 x 8-22			2.085,00
TB246	063 x 9-22			2.340,00
TB246-1	066 x 9-27			2.340,00

TARAMA BAŞLIKLARI

90°

KOD	ÜRÜN AÇIKLAMASI	YEDEKLER	UÇ TİPİ	FİYATI
TB247	040 x 4-16	M4x9x5.4 TCM 40	XNKT 0805 KRLY	1.492,00
TB248	050 x 5-22			1.787,00
TB249	063 x 6-22			2.085,00
TB250	080 x 7-27			2.512,00
TB251	100 x 8-32			2.978,00

TARAMA BAŞLIKLARI



88°

KOD	ÜRÜN AÇIKLAMASI	YEDEKLER	UÇ TİPİ	FİYATI
TB252	050 x 5-22 88°	M4.5x12x6.5 TCM 87	SNMX 1206 KRLY	1.403,00
TB253	063 x 6-22 88°			1.548,00
TB254	080 x 8-27 88°			2.008,00
TB255	100 x10-32 88°			2.733,00
TB256	125 x11-40 88°			3.530,00
TB257	160 x12-40 88°			4.933,00
TB258	200 x14-60 88°			7.350,00
TB259	250 x18-60 88°			9.780,00

TARAMA BAŞLIKLARI

45°



KOD	ÜRÜN AÇIKLAMASI	YEDEKLER	UÇ TİPİ	FİYATI
TB259-1	040 x 4-16 45°	  	SNKX 1206 KRLY	1.412,00
TB260	050 x 5-22 45°			1.644,00
TB261	063 x 6-22 45°			1.959,00
TB262	080 x 8-27 45°			2.273,00
TB263	100 x10-32 45°			2.515,00
TB264	125 x11-40 45°			4.208,00
TB265	160 x12-40 45°			5.102,00

TARAMA BAŞLIKLARI



KOD	ÜRÜN AÇIKLAMASI	YEDEKLER	UÇ TİPİ	FİYATI
TB266	040 x 4-16	M3x8x4.2 TCM 29	WNMX 09T3 KRLY	1.575,00
TB267	050 x 4-22			1.787,00
TB267-1	052 x 4-22			1.787,00
TB268	052 x 5-22			1.872,00
TB268-1	052 x 6-22			1.872,00
TB269	063 x 5-22			2.297,00
TB269-1	066 x 6-22			2.297,00
TB269-2	066 x 6-27			2.297,00
TB270	080 x 7-27			2.550,00
TB272	063 x 4-22			
TB273	080 x 5-27			2.382,00

TARAMA BAŞLIKLARI

90°



KOD	ÜRÜN AÇIKLAMASI	YEDEKLER	UÇ TİPİ	FİYATI
TB274	040 x 5-16	M2.5x7x3.5 TCM 18	APMT 11T3 KRLY	1.575,00
TB275	050 x 6-22			1.958,00
TB276	063 x 7-22			2.127,00
TB277	050 x 5-22		APMT 1604 KRLY	1.618,00
TB278	063 x 6-22			1.829,00
TB279	080 x 7-27			2.044,00
TB280	100 x 8-32			2.467,00

TARAMA BAŞLIKLARI

90°



KOD	ÜRÜN AÇIKLAMASI	YEDEKLER	UÇ TİPİ	FİYATI
TB281	040 x 5-16	M2.5x7x3.5 TCM 18	R390 11T3 SNDV	1.194,00
TB282	050 x 6-22			1.492,00
TB283	063 x 7-22			1.700,00
TB284	040 x 4-16	M3.5x10x5.3 TCM 34	R390 1704 SNDV	1.153,00
TB285	050 x 4-22			1.403,00
TB286	063 x 5-22			1.700,00
TB287	080 x 6-27			1.958,00
TB288	050 x 4-22		R390 1806 SNDV	1.958,00
TB289	063 x 5-22			2.127,00
TB290	080 x 6-27			2.425,00
TB291	100 x 8-32			2.550,00
TB292	125 x 9-40			4.212,00
TB293	160 x10-40			4.678,00

TARAMA BAŞLIKLARI
75°

KOD	ÜRÜN AÇIKLAMASI	YEDEKLER	UÇ TİPİ	FİYATI
TB296	063 x 4-22 F75T	M3.5x10x5.3 TCM 34	R390 1704 SNDV	1.660,00
TB297	080 x 5-27 F75T			2.002,00
TB298	100 x 6-32 F75T			2.382,00
TB299	080 x 4-27 F75T		R390 1806 SNDV	2.305,00
TB300	100 x 5-32 F75T			2.512,00
TB301	125 x 6-40 F75T			3.784,00

TARAMA BAŞLIKLARI
90°

KOD	ÜRÜN AÇIKLAMASI	YEDEKLER	UÇ TİPİ	FİYATI
TB303	050 x 4-22	M3.5x10x5.3 TCM 34	SEET 1203 SNDV / ZCC	1.504,00
TB304	063 x 5-22			1.859,00
TB305	080 x 6-27			2.112,00
TB306	100 x 7-32			2.518,00
TB307	125 x 8-40			3.498,00
TB308	160 x12-40			5.305,00

TARAMA BAŞLIKLARI
45°

KOD	ÜRÜN AÇIKLAMASI	YEDEKLER	UÇ TİPİ	FİYATI
TB309	050 x 4-22	M3.5x10x5.3 TCM 34	SEET 12T3 SNDV / ZCC	1.326,00
TB310	063 x 5-22			1.726,00
TB311	080 x 6-27			2.035,00
TB312	100 x 7-32			2.433,00
TB313	125 x 8-40			3.248,00
TB314	160 x10-40			5.305,00

TARAMA BAŞLIKLARI

KOD	ÜRÜN AÇIKLAMASI	YEDEKLER	UÇ TİPİ	FİYATI
TB318	040 x 4-16	 M3.5x11x4.8 TCM 35	SDMT 09T3 ZCC	1.508,00
TB319	050 x 5-22			1.821,00
TB320	052 x 5-22			1.821,00
TB321	063 x 6-22			2.072,00
TB322	080 x 7-27			2.337,00
TB323	100 x 8-32			2.876,00
TB324	050 x 4-22	M4x11x5.3 TCM 42	SDMT 1204 ZCC	1.683,00
TB325	052 x 4-22			1.734,00
TB326	063 x 5-22			2.061,00
TB327	080 x 6-27			2.238,00

TARAMA BAŞLIKLARI
45°

KOD	ÜRÜN AÇIKLAMASI	YEDEKLER	UÇ TİPİ	FİYATI
TB335	050 x 4-22		OFKT 05T3 ZCC	1.550,00
TB336	063 x 5-22			1.726,00
TB337	080 x 6-27			2.168,00
TB338	100 x 7-32			3.008,00

TARAMA BAŞLIKLARI

45°



KOD	ÜRÜN AÇIKLAMASI	YEDEKLER	UÇ TİPİ	FİYATI
TB339-1	063 x 5-22		ONHU 0604 ZCC	2.256,00
TB340	080 x 7-27			2.652,00
TB340-1	100 x 8-32			3.627,00
TB341	125 x 9-40			4.864,00
TB341-1	050 x 4-22		ONHU 08T6 ZCC	1.901,00
TB342-1	080 x 6-27			2.652,00
TB343	100 x 7-32			3.759,00
TB343-1	125 x 8-40			4.864,00
TB344	160 x10-60			5.749,00
TB345	063 x 5-22		ONHU 0806 ZCC	2.256,00
TB346	080 x 6-27			2.652,00
TB347	100 x 7-32			3.627,00

TARAMA BAŞLIKLARI

45°



KOD	ÜRÜN AÇIKLAMASI	YEDEKLER	UÇ TİPİ	FİYATI
TB350	050 x 5-22		SNEG 1205 ZCC	1.726,00
TB351	063 x 6-22			1.857,00
TB352	080 x 7-27			2.363,00
TB353	100 x 8-32			2.522,00
TB354	125 x10-40			4.204,00

TARAMA BAŞLIKLARI

90°



KOD	ÜRÜN AÇIKLAMASI	YEDEKLER	UÇ TİPİ	FİYATI
TB361	040 x 4-16		XOMX 1204 SCO	1.233,00
TB362	050 x 5-22	M3.5x8x4.8		1.532,00
TB363	063 x 6-22	TCM 32		1.829,00
TB364	080 x 8-22			2.085,00

TARAMA BAŞLIKLARI

90°



KOD	ÜRÜN AÇIKLAMASI	YEDEKLER	UÇ TİPİ	FİYATI
TB365	040 x 6-16		XNEX 0403 SCO / VNDR	1.958,00
TB366	050 x 7-22	M2.5x7x3.5		2.127,00
TB366-1	063 x 7-22	TCM 18		2.419,00
TB367	050 x 4-22		XNEX 0806 SCO / VNDR	1.829,00
TB368	063 x 5-22			2.127,00
TB369	080 x 7-27	M4x11x5.3		2.425,00
TB370	100 x 8-32	TCM 42		2.978,00
TB371	160 x12-40			5.102,00

TARAMA BAŞLIKLARI



KOD	ÜRÜN AÇIKLAMASI	YEDEKLER	UÇ TİPİ	FİYATI
TB372	040 x 6-16		LNMU 0303 TNGLY	1.909,00
TB373	050 x 7-22	M2.5x7x3.5		2.242,00
TB374	052 x 7-22	TCM 18		2.242,00
TB375	063 x 8-22			2.533,00

TARAMA BAŞLIKLARI

KOD	ÜRÜN AÇIKLAMASI	YEDEKLER	UÇ TİPİ	FİYATI
TB379	040 x 4-16	M3.5x11x4.8 TCM 35	RPMT 10T3 TNGLY	1.403,00
TB380	050 x 5-22			1.575,00
TB381	063 x 6-22			1.787,00
TB382	040 x 4-16	M4x11x5.3 TCM 42	RPMT 1204 TNGLY	1.403,00
TB383	050 x 5-22			1.575,00
TB384	063 x 6-22			1.787,00

TARAMA BAŞLIKLARI
90°

KOD	ÜRÜN AÇIKLAMASI	YEDEKLER	UÇ TİPİ	FİYATI
TB385	040 x 5-16	M2.5x7x3.5 TCM 18	APMT 1135 TGTC	1.652,00
TB386	050 x 6-22			1.958,00
TB387	063 x 7-22			2.127,00
TB388	040 x 5-16	M3.5x10x5.3 TCM 34	APKT 1204 TGTC	1.512,00
TB389	050 x 6-22			1.785,00
TB390	063 x 7-22			2.023,00
TB391	080 x 8-27			2.097,00

TARAMA BAŞLIKLARI

KOD	ÜRÜN AÇIKLAMASI	YEDEKLER	UÇ TİPİ	FİYATI
TB392	040 x 6-16	M2.5x7x3.5 TCM 18	BLMP 0603 TGTC	1.618,00
TB393	050 x 7-22			1.872,00
TB394	063 x 8-22			2.104,00

TARAMA BAŞLIKLARI
90°

KOD	ÜRÜN AÇIKLAMASI	YEDEKLER	UÇ TİPİ	FİYATI
TB395	040 x 4-16	M2.5x7x3.5 TCM 18	3PKT 1004 TGTC	1.829,00
TB395-1	050 x 5-22			2.170,00
TB396	063 x 8-22			2.467,00
TB396-1	050 x 4-22	M4.5x12x6.5 TCM 87	3PKT 1505 TGTC	1.717,00
TB397	063 x 5-22			2.055,00
TB397-1	080 x 7-27			2.515,00
TB397-2	100 x 8-32			3.264,00

TARAMA BAŞLIKLARI
90°

KOD	ÜRÜN AÇIKLAMASI	YEDEKLER	UÇ TİPİ	FİYATI
TB398	040 x 5-16	M3x8x4.2 TCM 29	6NGU 0604 TGTC	1.787,00
TB399	050 x 5-22			2.002,00
TB400	063 x 6-22			2.213,00
TB401	050 x 5-22	M4x10x5.8 TCM 41	6NGU 0905 TGTC	1.660,00
TB402	063 x 6-22			1.872,00
TB403	080 x 7-27			2.255,00
TB404	100 x 8-32			2.765,00
TB405	125 x 10-40			3.488,00

TARAMA BAŞLIKLARI

90°



KOD	ÜRÜN AÇIKLAMASI	YEDEKLER	UÇ TİPİ	FİYATI
TB406	040 x 4-16		EDPT 1404 KNMT	1.660,00
TB407	050 x 5-22			1.958,00
TB408	063 x 6-22			2.213,00
TB409	080 x 7-27			2.467,00
TB410	100 x 8-32			2.640,00
TB411	050 x 4-22	M3x8x4.2 TCM 29	EDPT 1805 KNMT	1.958,00
TB412	063 x 5-22			2.213,00
TB413	080 x 6-27			2.467,00

TARAMA BAŞLIKLARI

90°



KOD	ÜRÜN AÇIKLAMASI	YEDEKLER	UÇ TİPİ	FİYATI
TB414	040 x 5-16		LNGU 1104 KNMT	1.492,00
TB415	050 x 6-22			1.660,00
TB416	063 x 6-22			1.958,00
TB417	080 x 8-27			2.213,00

TARAMA BAŞLIKLARI

90°



KOD	ÜRÜN AÇIKLAMASI	YEDEKLER	UÇ TİPİ	FİYATI
TB418	063 x 5-22		TNGX 1905 KNMT	2.382,00
TB419	080 x 6-27			2.724,00

TARAMA BAŞLIKLARI

90°



KOD	ÜRÜN AÇIKLAMASI	YEDEKLER	UÇ TİPİ	FİYATI
TB420	050 x 5-22		XNMM 1607 MİTSB	1.660,00
TB421	063 x 6-22			1.872,00
TB422	080 x 7-27			2.127,00

TARAMA BAŞLIKLARI

90°



KOD	ÜRÜN AÇIKLAMASI	YEDEKLER	UÇ TİPİ	FİYATI
TB426	040 x 6-16	M2.5x7x3.5 TCM 18	AOMT 1236 MİTSB	1.618,00
TB427	050 x 7-22			1.917,00
TB428	063 x 8-22			2.170,00
TB429	080 x 9-27			2.467,00
TB431	050 x 5-22		AOMT 1848 MİTSB	1.635,00
TB432	063 x 5-22			1.844,00
TB433	080 x 6-27			2.320,00
TB434	100 x 8-32			2.735,00

TARAMA BAŞLIKLARI
90°

KOD	ÜRÜN AÇIKLAMASI	YEDEKLER	UÇ TİPİ	FİYATI
TB424	050 x 4-22		XDGT 1550	1.660,00
TB425	063 x 5-22		MİTSB	1.872,00

TARAMA BAŞLIKLARI
90°

KOD	ÜRÜN AÇIKLAMASI	YEDEKLER	UÇ TİPİ	FİYATI
TB435	050 x 4-22		SOMT 12T3 MİTSB	1.275,00
TB436	063 x 5-22	M5x12x7 TCM 46		1.618,00
TB437	080 x 6-27			1.917,00
TB438	100 x 7-32			2.127,00

TARAMA BAŞLIKLARI
90°

KOD	ÜRÜN AÇIKLAMASI	YEDEKLER	UÇ TİPİ	FİYATI
TB440	050 x 4-22		WNMU 0806 SANG	1.901,00
TB441	063 x 5-22			2.211,00
TB442	080 x 6-27	M4.5x12x6.5 TCM 87		2.522,00
TB443	100 x 7-32			3.096,00
TB444	125 x 8-40			3.981,00

TARAMA BAŞLIKLARI
90°

KOD	ÜRÜN AÇIKLAMASI	YEDEKLER	UÇ TİPİ	FİYATI
TB445	040 x 5-16		3PGX 1004	1.673,00
TB446	050 x 6-22		SANG	1.892,00
TB447	050 x 5-22		3PGX 1505 SANG	1.682,00
TB448	063 x 6-22			1.901,00
TB449	080 x 7-27			2.035,00
TB451	125 x10-40			3.892,00

TARAMA BAŞLIKLARI
45°

KOD	ÜRÜN AÇIKLAMASI	YEDEKLER	UÇ TİPİ	FİYATI
TB453	050 x 4-22		PNMU 0905 SANG	1.682,00
TB453-1	063 x 5-22			1.992,00
TB454	080 x 6-27			2.522,00
TB455	100 x 7-32			2.875,00
TB456	125 x10-40			4.335,00

TARAMA BAŞLIKLARI



KOD	ÜRÜN AÇIKLAMASI	YEDEKLER	UÇ TİPİ	FİYATI
TB457	050 x 5-22		SPMW 1204 SANG	1.857,00
TB458	063 x 5-22			2.125,00
TB459	080 x 5-27			2.433,00
TB460	100 x 8-32			2.787,00

TARAMA BAŞLIKLARI

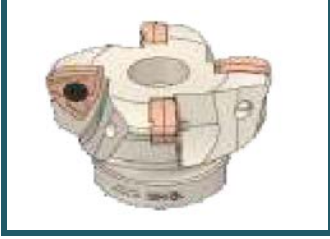

KOD	ÜRÜN AÇIKLAMASI	YEDEKLER	UÇ TİPİ	FİYATI
TB462	040 x 5-16	M3x8x4.2 TCM 29	SOMW 0803 SANG	1.638,00
TB463	050 x 6-22			1.726,00
TB464	063 x 7-22			2.035,00

TARAMA BAŞLIKLARI



KOD	ÜRÜN AÇIKLAMASI	YEDEKLER	UÇ TİPİ	FİYATI
TB465	052 x 3-22		UNEU 1307R	1.660,00
TB466	063 x 4-22		İNGRSL	1.958,00

TARAMA BAŞLIKLARI



90°

KOD	ÜRÜN AÇIKLAMASI	YEDEKLER	UÇ TİPİ	FİYATI
TB467	050 x 7-22	M3x8x4.2 TCM 29	BOMT 1304 İNGRSL	1.660,00
TB468	063 x 8-22			1.902,00
TB469	080 x10-27			2.382,00

TARAMA BAŞLIKLARI



90°

KOD	ÜRÜN AÇIKLAMASI	YEDEKLER	UÇ TİPİ	FİYATI
TB470	050 x 4-22		AOMT 1605 İNGRSL	1.532,00
TB471	063 x 5-22			1.787,00
TB472	080 x 6-27			2.213,00
TB473	100 x 8-32			2.640,00

TARAMA BAŞLIKLARI



KOD	ÜRÜN AÇIKLAMASI	YEDEKLER	UÇ TİPİ	FİYATI
TB474	040 x 4-16	M3x8x4.2 TCM 29	SDMT 1004	1.597,00
TB475	050 x 5-22		BHLR	1.700,00

TARAMA BAŞLIKLARI



KOD	ÜRÜN AÇIKLAMASI	YEDEKLER	UÇ TİPİ	FİYATI
TB478	050 x 4-22		XDKT 1505	1.449,00
TB479	063 x 5-22		CRTZ	1.787,00

TARAMA BAŞLIKLARI



90°

KOD	ÜRÜN AÇIKLAMASI	YEDEKLER	UÇ TİPİ	FİYATI
TB515	040 x 5-16	M2.5x7x3.5 TCM 18	APKT 11T3 ZCC	1.638,00
TB516	050 x 6-22			2.035,00
TB517	063 x 7-22			2.211,00

TARAMA BAŞLIKLARI
90°

KOD	ÜRÜN AÇIKLAMASI	YEDEKLER	UÇ TİPİ	FİYATI
TB480	040 x 4-16	M3x8x4.2 TCM 29	ANGX 1105 ZCC	1.326,00
TB481	050 x 6-22			1.458,00
TB482	063 x 7-22			1.817,00



TARAMA BAŞLIKLARI
90°

KOD	ÜRÜN AÇIKLAMASI	YEDEKLER	UÇ TİPİ	FİYATI
TB486	040 x 4-16	M3.5x14x5.3 TCM 38	LNGX 1205 VNDR	1.363,00
TB487	050 x 5-22			1.575,00
TB488	063 x 6-22			1.829,00
TB489	080 x 5-27			2.127,00

TARAMA BAŞLIKLARI
45°

KOD	ÜRÜN AÇIKLAMASI	YEDEKLER	UÇ TİPİ	FİYATI
TB500	050 x 4-22	M4x14x5.3 TCM 43	HNGX 0906 PRMT	1.917,00
TB501	063 x 5-22			2.079,00
TB503	080 x 6-27			2.297,00
TB504	100 x 8-32			3.482,00
TB505	125 x10-40			4.522,00
TB506	160 x12-40			5.513,00
TB507	200 x12-60			7.230,00
TB508	250 x12-60			9.357,00
TB510	300 x16-60			13.975,00

VİDALI TAKIMLAR

KOD	ÜRÜN AÇIKLAMASI	YEDEKLER	UÇ TİPİ	FİYATI
VTM002	25x2 M12	  	RDMT 1003 İSO	1.403,00
VTM006	32x4 M16			1.575,00
VTM008	35x4 M16			1.618,00
VTM010	40x4 M16			1.660,00
VTM012	42x5 M16			1.700,00
VTM014	25x2 M12	M3.5x10x5.3 TCM 34	RDMT 12T3 İSO	1.449,00
VTM016	32x3 M16			1.575,00
VTM018	35x3 M16			1.575,00
VTM022	42x4 M16			1.700,00
VTM024	32x2 M16	M4.5x12x6.5 TCM 87	RDMT 1604 İSO	1.575,00
VTM026	40x2 M16			1.660,00

VİDALI TAKIMLAR



KOD	ÜRÜN AÇIKLAMASI	YEDEKLER	UÇ TİPİ	FİYATI
VTM028	20x2 M10	M3.5x8x5.3 TCM 33	RPMW 1003 İSO	1.532,00
VTM030	25x2 M12			1.575,00
VTM032	32x4 M16			1.660,00
VTM034	42x5 M16			1.787,00

VİDALI TAKIMLAR

90°



KOD	ÜRÜN AÇIKLAMASI	YEDEKLER	UÇ TİPİ	FİYATI
VTM036	16x2 M08	M2.5x7x3.5 TCM 18	APKT 1003 İSO	1.382,00
VTM038	20x3 M10			1.403,00
VTM040	25x3 M12			1.532,00
VTM042	32x4 M16			1.618,00
VTM044	35x4 M16			1.660,00
VTM046	40x5 M16			1.748,00
VTM050	25x2 M12	M3.5x8x5.3 TCM 33	APKT 1604 İSO	1.532,00
VTM052	32x3 M16			1.660,00
VTM054	40x4 M16			1.748,00

VİDALI TAKIMLAR



KOD	ÜRÜN AÇIKLAMASI	YEDEKLER	UÇ TİPİ	FİYATI
VTM066	32x4 M16		RDHX 1003 KYCR	1.723,00
VTM068	42x5 M16			1.943,00
VTM070	25x3 M12			1.458,00
VTM078	42x5 M16			1.857,00

VİDALI TAKIMLAR



KOD	ÜRÜN AÇIKLAMASI	YEDEKLER	UÇ TİPİ	FİYATI
VTM080	32x3 M16	M4x9x5.4 TCM 40	SOMT 1004 KYCR	1.682,00
VTM082	35x3 M16			1.682,00
VTM084	40x4 M16			1.817,00
VTM086	42x4 M16		1.817,00	
VTM088	42x3 M16		SOMT 1404	1.901,00

VİDALI TAKIMLAR



KOD	ÜRÜN AÇIKLAMASI	YEDEKLER	UÇ TİPİ	FİYATI
VTM090	20X3 M10	M3x8x4 TCM 28	LOGU 0303 KYCR	1.974,00
VTM092	25X4 M12			2.069,00
VTM094	32X5 M16			2.160,00
VTM096	35X5 M16			2.160,00
VTM098	40X6 M16			2.252,00
VTM100	42X6 M16			2.252,00

VİDALI TAKIMLAR

90°



KOD	ÜRÜN AÇIKLAMASI	YEDEKLER	UÇ TİPİ	FİYATI
VTM102	20X3 M10	M2.5x7x3.5 TCM 18	APMT 11T3 KRLY	1.492,00
VTM104	25X4 M12			1.532,00
VTM106	32X4 M16			1.700,00

VİDALI TAKIMLAR

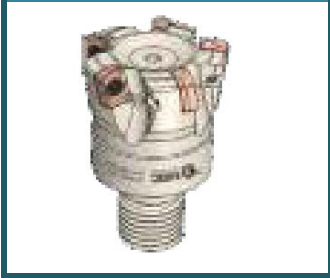

KOD	ÜRÜN AÇIKLAMASI	YEDEKLER	UÇ TİPİ	FİYATI
VTM108	16X2 M08		WNMX 0603 KRLY	1.363,00
VTM110	20X3 M10			1.575,00
VTM110-1	25X3 M12			1.660,00
VTM112	25X4 M12			1.700,00
VTM114	32X5 M16			1.829,00
VTM116	35X5 M16			1.829,00
VTM118	25x2 M12	M3x8x4.2 TCM 29	WNMX 09T3 KRLY	1.427,00
VTM120	32x3 M16			1.660,00
VTM122	35x4 M16			1.748,00
VTM124	40x4 M16			1.853,00
VTM126	42x4 M16			1.917,00

VİDALI TAKIMLAR

KOD	ÜRÜN AÇIKLAMASI	YEDEKLER	UÇ TİPİ	FİYATI
VTM130	35x5 M16		LNMT 0603 KRLY	1.700,00
VTM132	40x6 M16			1.958,00

VİDALI TAKIMLAR

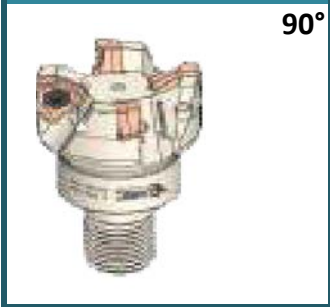
KOD	ÜRÜN AÇIKLAMASI	YEDEKLER	UÇ TİPİ	FİYATI
VTM134	16x2 M08	M3x8x4.2 TCM 29	LNMX 0603 KRLY	1.492,00
VTM136	20x3 M10			1.492,00
VTM138	25x4 M12			1.575,00
VTM140	32x5 M16			1.700,00
VTM142	35x5 M16			1.700,00
VTM144	40x6 M16			1.958,00
VTM146	42x6 M16			1.958,00

VİDALI TAKIMLAR

90°

KOD	ÜRÜN AÇIKLAMASI	YEDEKLER	UÇ TİPİ	FİYATI
VTM150	20x2 M10	M3x8x4.2 TCM 29	XNKT 0604 KRLY	1.660,00
VTM152	25x3 M12			1.748,00
VTM154	32x4 M16			1.872,00
VTM156	42x5 M16			2.002,00
VTM158	32x3 M16	M4x9x5.4 TCM 40	XNKT 0805 KRLY	1.872,00
VTM160	40x4 M16			2.002,00
VTM162	42x4 M16			2.044,00

VİDALI TAKIMLAR

KOD	ÜRÜN AÇIKLAMASI	YEDEKLER	UÇ TİPİ	FİYATI
VTM164	20x3 M10	M2.5x7x3.5 TCM 18	BLMP 0603 TGTC	1.660,00
VTM166	25x4 M12			1.748,00
VTM168	32x5 M16			1.808,00
VTM170	40x6 M16			2.085,00
VTM172	42x6 M16			2.127,00

VİDALI TAKIMLAR

90°



KOD	ÜRÜN AÇIKLAMASI	YEDEKLER	UÇ TİPİ	FİYATI
VTM173	25x4 M12	M2.5x7x3.5 TCM 18	XNEX 0403 SCO	1.748,00
VTM174	32x4 M16			1.723,00
VTM175	32x5 M16			1.872,00
VTM179	40x3 M16	M4x11x5.3	XNEX 0806	1.814,00

VİDALI TAKIMLAR

90°



KOD	ÜRÜN AÇIKLAMASI	YEDEKLER	UÇ TİPİ	FİYATI
VTM184	25x3 M12	M3x8x4.2 TCM 29	BOMT 1304 İNGRSL	1.532,00
VTM186	32x4 M16			1.660,00

VİDALI TAKIMLAR

90°



KOD	ÜRÜN AÇIKLAMASI	YEDEKLER	UÇ TİPİ	FİYATI
VTM188	25x2 M12		AOMT 1605 İNGRSL	1.532,00
VTM190	32x3 M16			1.660,00
VTM192	40x4 M16			1.748,00

VİDALI TAKIMLAR

90°



KOD	ÜRÜN AÇIKLAMASI	YEDEKLER	UÇ TİPİ	FİYATI
VTM198	25x3 M12	M2.5x7x3.5 TCM 18	APMT 1135 SANG	1.592,00
VTM200	32x4 M16			1.726,00

VİDALI TAKIMLAR



KOD	ÜRÜN AÇIKLAMASI	YEDEKLER	UÇ TİPİ	FİYATI
VTM210	32x2 M16	 M4x11x5.3 TCM 42	SPMW 1204 SANG	1.638,00
VTM212	40x3 M16			 KEP 13  M4x11x5.3 TCM 42

VİDALI TAKIMLAR



KOD	ÜRÜN AÇIKLAMASI	YEDEKLER	UÇ TİPİ	FİYATI
VTM214	20x2 M10	M3x8x4.2 TCM 29	SOMW 0803 SANG	1.458,00
VTM216	25x3 M12			1.592,00
VTM218	32x4 M16			1.726,00
VTM220	40x5 M16			1.857,00
VTM222	42x5 M16			1.857,00

VİDALI TAKIMLAR

KOD	ÜRÜN AÇIKLAMASI	YEDEKLER	UÇ TİPİ	FİYATI
VTM224	20x3 M10		XDHX 06	1.638,00
VTM226	25x4 M12		SANG	1.726,00
VTM230	35x3 M16		XDHX 10 SANG	1.768,00

VİDALI TAKIMLAR

KOD	ÜRÜN AÇIKLAMASI	YEDEKLER	UÇ TİPİ	FİYATI
VTM238	25x3 M12		SDMT 09T3 ZCC	1.483,00
VTM240	32x3 M16	M3.5x8x4.8 TCM 32		1.638,00
VTM242	35x4 M16			1.682,00
VTM244	40x4 M16			1.817,00

VİDALI TAKIMLAR

KOD	ÜRÜN AÇIKLAMASI	YEDEKLER	UÇ TİPİ	FİYATI
VTM262	25x2 M12		XPHT 25 R12.5 ZCC	1.458,00
VTM264	32x2 M16		XPHT 32 R16 ZCC	1.592,00

VİDALI TAKIMLAR

KOD	ÜRÜN AÇIKLAMASI	YEDEKLER	UÇ TİPİ	FİYATI
VTM266	25x2 M12	M3x8x4.2 TCM 29	SDMT 1004	1.532,00
VTM268	32x3 M16		BHLR	1.660,00

VİDALI TAKIMLAR

90°

KOD	ÜRÜN AÇIKLAMASI	YEDEKLER	UÇ TİPİ	FİYATI
VTM270	25x2 M12		XDKT 1505	1.532,00
VTM272	32x3 M16		CRTZ	1.639,00

VİDALI TAKIMLAR

90°

KOD	ÜRÜN AÇIKLAMASI	YEDEKLER	UÇ TİPİ	FİYATI
VTM274	25x2 M12		XDHT 1904	1.532,00
VTM276	40x4 M16		CRTZ	1.787,00

VİDALI TAKIMLAR

90°

KOD	ÜRÜN AÇIKLAMASI	YEDEKLER	UÇ TİPİ	FİYATI
VTM280	21x3 M10		4NKT 0603 TGTC	1.829,00
VTM282	26x3 M12	M3x8x4 TCM 28		1.748,00
VTM284	32x4 M16			2.002,00

VİDALI TAKIMLAR



KOD	ÜRÜN AÇIKLAMASI	YEDEKLER	UÇ TİPİ	FİYATI
VTM286	20x3 M10	M2.5x7x3.5 TCM 18	LNMU 0303 TNGLY	1.744,00
VTM288	25x4 M12			1.909,00
VTM290	32x4 M16			2.035,00
VTM292	32x5 M16			2.035,00
VTM294	35x4 M16			2.035,00
VTM296	40x6 M16			2.074,00
VTM298	42x5 M16			2.199,00
VTM300	42x6 M16			2.199,00

VİDALI TAKIMLAR



KOD	ÜRÜN AÇIKLAMASI	YEDEKLER	UÇ TİPİ	FİYATI
VTM302	16x2 M08	M2.5x7x3.5 TCM 18	XDHW 0602 PLBT	1.449,00
VTM304	17x2 M08			1.449,00
VTM306	20x3 M10			1.532,00
VTM308	21x3 M10			1.532,00
VTM310	25x3 M12			1.660,00
VTM312	32x5 M16			1.787,00
VTM314	35x5 M16			1.787,00
VTM316	42x6 M16			1.829,00

VİDALI TAKIM TUTUCULARI



KOD	ÜRÜN AÇIKLAMASI	FİYATI
VTM500	25 - M12 - L120 -IC VİDALI TAKIM TUTUCUSU	1.829,00
VTM501	25 - M12 - L160 -IC VİDALI TAKIM TUTUCUSU	1.958,00
VTM502	25 - M12 - L200 -IC VİDALI TAKIM TUTUCUSU	2.512,00
VTM503	32 - M16 - L120 -IC VİDALI TAKIM TUTUCUSU	1.829,00
VTM504	32 - M16 - L160 -IC VİDALI TAKIM TUTUCUSU	2.085,00
VTM505	32 - M16 - L200 -IC VİDALI TAKIM TUTUCUSU	2.765,00

D-2 WCM_ U-DRİLLER



KOD	ÜRÜN AÇIKLAMASI	YEDEKLER	UÇ TİPİ	FİYATI
UM016	16 D-2 UDRİL MATKAP	M2.5x6x3.5 TCM 16	WCM_ 0302 TGTC/ZCC	1.991,00
UM016-1	16.5 D-2 UDRİL MATKAP			1.991,00
UM017	17 D-2 UDRİL MATKAP			1.991,00
UM017-1	17.5 D-2 UDRİL MATKAP			1.991,00
UM018	18 D-2 UDRİL MATKAP			1.991,00
UM018-1	18.5 D-2 UDRİL MATKAP			1.991,00
UM019	19 D-2 UDRİL MATKAP			1.991,00
UM019-1	19.5 D-2 UDRİL MATKAP			1.991,00
UM020	20 D-2 UDRİL MATKAP	M2.5x7x3.5 TCM 18	WCM_ 0402 TGTC/ZCC	2.050,00
UM020-1	20.5 D-2 UDRİL MATKAP			2.050,00
UM021	21 D-2 UDRİL MATKAP			2.050,00
UM021-1	21.5 D-2 UDRİL MATKAP			2.050,00
UM022	22 D-2 UDRİL MATKAP			2.050,00
UM022-1	22.5 D-2 UDRİL MATKAP			2.050,00
UM023	23 D-2 UDRİL MATKAP			2.050,00
UM023-1	23.5 D-2 UDRİL MATKAP			2.177,00

D-2 WCM_ U-DRİLLER

KOD	ÜRÜN AÇIKLAMASI	YEDEKLER	UÇ TİPİ	FİYATI
UM024	24 D-2 UDRİL MATKAP	M3x8x4.2 TCM 29	WCM_ 0503 TGTC/ZCC	2.177,00
UM024-1	24.5 D-2 UDRİL MATKAP			2.177,00
UM025	25 D-2 UDRİL MATKAP			2.177,00
UM025-1	25.5 D-2 UDRİL MATKAP			2.177,00
UM026	26 D-2 UDRİL MATKAP			2.177,00
UM026-1	26.5 D-2 UDRİL MATKAP			2.177,00
UM027	27 D-2 UDRİL MATKAP			2.177,00
UM027-1	27.5 D-2 UDRİL MATKAP			2.177,00
UM028	28 D-2 UDRİL MATKAP			2.177,00
UM028-1	28.5 D-2 UDRİL MATKAP			2.177,00
UM029	29 D-2 UDRİL MATKAP			2.177,00
UM029-1	29.5 D-2 UDRİL MATKAP			2.177,00
UM030	30 D-2 UDRİL MATKAP	M3.5x11x4.8 TCM 35	WCM_ 06T3 TGTC/ZCC	2.464,00
UM031	31 D-2 UDRİL MATKAP			2.464,00
UM032	32 D-2 UDRİL MATKAP			2.464,00
UM033	33 D-2 UDRİL MATKAP			2.464,00
UM034	34 D-2 UDRİL MATKAP			2.464,00
UM035	35 D-2 UDRİL MATKAP			2.464,00
UM036	36 D-2 UDRİL MATKAP			2.464,00
UM037	37 D-2 UDRİL MATKAP			2.464,00
UM038	38 D-2 UDRİL MATKAP			2.464,00
UM039	39 D-2 UDRİL MATKAP			2.464,00
UM040	40 D-2 UDRİL MATKAP			2.464,00
UM041	41 D-2 UDRİL MATKAP			2.545,00
UM042	42 D-2 UDRİL MATKAP	2.545,00		
UM043	43 D-2 UDRİL MATKAP	2.545,00		
UM044	44 D-2 UDRİL MATKAP	2.545,00		
UM045	45 D-2 UDRİL MATKAP	M4x14x5.3 TCM 43	WCM_ 0804 TGTC/ZCC	2.670,00
UM046	46 D-2 UDRİL MATKAP			2.875,00
UM047	47 D-2 UDRİL MATKAP			3.081,00
UM048	48 D-2 UDRİL MATKAP			3.204,00
UM049	49 D-2 UDRİL MATKAP			3.328,00
UM050	50 D-2 UDRİL MATKAP			3.494,00

D-3 WCM_ U-DRİLLER

KOD	ÜRÜN AÇIKLAMASI	YEDEKLER	UÇ TİPİ	FİYATI
UM115-1	15.5 D-3 UDRİL MATKAP	M2.5x6x3.5 TCM 16	WCM_ 0302 TGTC/ZCC	2.134,00
UM116	16 D-3 UDRİL MATKAP			2.134,00
UM116-1	16.5 D-3 UDRİL MATKAP			2.134,00
UM117	17 D-3 UDRİL MATKAP			2.134,00
UM117-1	17.5 D-3 UDRİL MATKAP			2.134,00
UM118	18 D-3 UDRİL MATKAP			2.134,00
UM118-1	18.5 D-3 UDRİL MATKAP			2.134,00
UM119	19 D-3 UDRİL MATKAP			2.134,00
UM119-1	19.5 D-3 UDRİL MATKAP			2.134,00
UM120	20 D-3 UDRİL MATKAP	M2.5x7x3.5 TCM 18	WCM_ 0402 TGTC/ZCC	2.260,00
UM120-1	20.5 D-3 UDRİL MATKAP			2.260,00
UM121	21 D-3 UDRİL MATKAP			2.260,00
UM121-1	21.5 D-3 UDRİL MATKAP			2.260,00
UM122	22 D-3 UDRİL MATKAP			2.260,00

D-3 WCM_ U-DRİLLER



KOD	ÜRÜN AÇIKLAMASI	YEDEKLER	UÇ TİPİ	FİYATI
UM122-1	22.5 D-3 UDRİL MATKAP	M2.5x7x3.5 TCM 18	WCM_ 0402 TGTC/ZC	2.260,00
UM123	23 D-3 UDRİL MATKAP			2.260,00
UM123-1	23.5 D-3 UDRİL MATKAP			2.260,00
UM124	24 D-3 UDRİL MATKAP	M3x8x4.2 TCM 29	WCM_ 0503 TGTC/ZCC	2.301,00
UM124-1	24.5 D-3 UDRİL MATKAP			2.301,00
UM125	25 D-3 UDRİL MATKAP			2.301,00
UM125-1	25.5 D-3 UDRİL MATKAP			2.301,00
UM126	26 D-3 UDRİL MATKAP			2.301,00
UM126-1	26.5 D-3 UDRİL MATKAP			2.301,00
UM127	27 D-3 UDRİL MATKAP			2.301,00
UM127-1	27.5 D-3 UDRİL MATKAP			2.301,00
UM128	28 D-3 UDRİL MATKAP			2.301,00
UM128-1	28.5 D-3 UDRİL MATKAP			2.301,00
UM129	29 D-3 UDRİL MATKAP			2.301,00
UM129-1	29.5 D-3 UDRİL MATKAP	2.301,00		
UM130	30 D-3 UDRİL MATKAP	M3.5x11x4.8 TCM 35	WCM_ 06T3 TGTC/ZCC	2.505,00
UM130-1	30.5 D-3 UDRİL MATKAP			2.505,00
UM131	31 D-3 UDRİL MATKAP			2.505,00
UM131-1	31.5 D-3 UDRİL MATKAP			2.505,00
UM132	32 D-3 UDRİL MATKAP			2.505,00
UM132-1	32.5 D-3 UDRİL MATKAP			2.505,00
UM133	33 D-3 UDRİL MATKAP			2.505,00
UM133-1	33.5 D-3 UDRİL MATKAP			2.505,00
UM134	34 D-3 UDRİL MATKAP			2.505,00
UM134-1	34.5 D-3 UDRİL MATKAP			2.505,00
UM135	35 D-3 UDRİL MATKAP			2.505,00
UM135-1	35.5 D-3 UDRİL MATKAP			2.505,00
UM136	36 D-3 UDRİL MATKAP			2.505,00
UM136-1	36.5 D-3 UDRİL MATKAP			2.505,00
UM137	37 D-3 UDRİL MATKAP			2.505,00
UM137-1	37.5 D-3 UDRİL MATKAP			2.505,00
UM138	38 D-3 UDRİL MATKAP			2.505,00
UM138-1	38.5 D-3 UDRİL MATKAP			2.505,00
UM139	39 D-3 UDRİL MATKAP			2.505,00
UM139-1	39.5 D-3 UDRİL MATKAP	2.505,00		
UM140	40 D-3 UDRİL MATKAP	2.505,00		
UM141	41 D-3 UDRİL MATKAP	2.792,00		
UM142	42 D-3 UDRİL MATKAP	2.792,00		
UM143	43 D-3 UDRİL MATKAP	2.792,00		
UM144	44 D-3 UDRİL MATKAP	2.792,00		
UM145	45 D-3 UDRİL MATKAP	M4x14x5.3 TCM 43	WCM_ 0804 TGTC/ZCC	2.917,00
UM146	46 D-3 UDRİL MATKAP			3.081,00
UM147	47 D-3 UDRİL MATKAP			3.204,00
UM148	48 D-3 UDRİL MATKAP			3.367,00
UM149	49 D-3 UDRİL MATKAP			3.494,00
UM150	50 D-3 UDRİL MATKAP			3.738,00

D-4 WCM_ U-DRİLLER

KOD	ÜRÜN AÇIKLAMASI	YEDEKLER	UÇ TİPİ	FİYATI
UM215-1	15.5 D-4 UDRİL MATKAP	M2.5x6x3.5 TCM 16	WCM_ 0302 TGTC/ZCC	2.629,00
UM216	16 D-4 UDRİL MATKAP			2.629,00
UM217	17 D-4 UDRİL MATKAP			2.629,00
UM217-1	17.5 D-4 UDRİL MATKAP			2.629,00
UM218	18 D-4 UDRİL MATKAP			2.629,00
UM219	19 D-4 UDRİL MATKAP			2.629,00
UM219-1	19.5 D-4 UDRİL MATKAP			2.629,00
UM220	20 D-4 UDRİL MATKAP			2.754,00
UM221	21 D-4 UDRİL MATKAP	M2.5x7x3.5 TCM 18	WCM_ 0402 TGTC/ZCC	2.754,00
UM222	22 D-4 UDRİL MATKAP			2.754,00
UM223	23 D-4 UDRİL MATKAP			2.754,00
UM223-1	23.5 D-4 UDRİL MATKAP			2.754,00
UM224	24 D-4 UDRİL MATKAP	M3x8x4.2 TCM 29	WCM_ 0503 TGTC/ZCC	2.875,00
UM225	25 D-4 UDRİL MATKAP			2.875,00
UM225-1	25.5 D-4 UDRİL MATKAP			2.875,00
UM226	26 D-4 UDRİL MATKAP			2.875,00
UM227	27 D-4 UDRİL MATKAP			2.875,00
UM227-1	27.5 D-4 UDRİL MATKAP			2.875,00
UM228	28 D-4 UDRİL MATKAP			2.875,00
UM229	29 D-4 UDRİL MATKAP			2.875,00
UM230	30 D-4 UDRİL MATKAP			3.120,00
UM231	31 D-4 UDRİL MATKAP			M3.5x11x4.8 TCM 35
UM231-1	31.5 D-4 UDRİL MATKAP	3.120,00		
UM232	32 D-4 UDRİL MATKAP	3.120,00		
UM233	33 D-4 UDRİL MATKAP	3.120,00		
UM233-1	33.5 D-4 UDRİL MATKAP	3.120,00		
UM234	34 D-4 UDRİL MATKAP	3.120,00		
UM235	35 D-4 UDRİL MATKAP	3.120,00		
UM236	36 D-4 UDRİL MATKAP	3.120,00		
UM237	37 D-4 UDRİL MATKAP	3.120,00		
UM238	38 D-4 UDRİL MATKAP	3.120,00		
UM238-1	38.5 D-4 UDRİL MATKAP	3.120,00		
UM239	39 D-4 UDRİL MATKAP	3.120,00		
UM240	40 D-4 UDRİL MATKAP	3.120,00		
UM241	41 D-4 UDRİL MATKAP	3.367,00		
UM241-1	41.5 D-4 UDRİL MATKAP	3.367,00		
UM242	42 D-4 UDRİL MATKAP	3.367,00		
UM243	43 D-4 UDRİL MATKAP	3.367,00		
UM244	44 D-4 UDRİL MATKAP	3.367,00		
UM245	45 D-4 UDRİL MATKAP	M4x14x5.3 TCM 43	WCM_ 0804 TGTC/ZCC	3.530,00
UM246	46 D-4 UDRİL MATKAP			3.738,00
UM247	47 D-4 UDRİL MATKAP			3.985,00
UM248	48 D-4 UDRİL MATKAP			4.105,00
UM249	49 D-4 UDRİL MATKAP			4.516,00
UM250	50 D-4 UDRİL MATKAP			4.724,00

D-5 WCM_ U-DRİLLER



KOD	ÜRÜN AÇIKLAMASI	YEDEKLER	UÇ TİPİ	FİYATI
UM316	16 D-5 UDRİL MATKAP	M2.5x6x3.5 TCM 16	WCM_ 0302 TGTC/ZCC	3.328,00
UM317	17 D-5 UDRİL MATKAP			3.328,00
UM318	18 D-5 UDRİL MATKAP			3.328,00
UM319	19 D-5 UDRİL MATKAP			3.494,00
UM320	20 D-5 UDRİL MATKAP	M2.5x7x3.5 TCM 18	WCM_ 0402 TGTC/ZCC	3.494,00
UM321	21 D-5 UDRİL MATKAP			3.494,00
UM322	22 D-5 UDRİL MATKAP			3.494,00
UM323	23 D-5 UDRİL MATKAP			3.781,00
UM324	24 D-5 UDRİL MATKAP	M3x8x4.2 TCM 29	WCM_ 0503 TGTC/ZCC	3.781,00
UM325	25 D-5 UDRİL MATKAP			3.781,00
UM326	26 D-5 UDRİL MATKAP			3.781,00
UM327	27 D-5 UDRİL MATKAP			3.781,00
UM328	28 D-5 UDRİL MATKAP			3.781,00
UM329	29 D-5 UDRİL MATKAP			3.781,00
UM330	30 D-5 UDRİL MATKAP	M3.5x11x4.8	WCM_ 06T3	3.902,00

D-2 SPMG U-DRİLLER



KOD	ÜRÜN AÇIKLAMASI	YEDEKLER	UÇ TİPİ	FİYATI
UM412-1	12.5 D-2 UDRİL MATKAP	M2x5x2.7 TCM 06	SPMG 0502 TGTC / PLBT ZCC / KLP	1.991,00
UM413	13 D-2 UDRİL MATKAP			1.991,00
UM413-1	13.5 D-2 UDRİL MATKAP			1.991,00
UM414	14 D-2 UDRİL MATKAP			1.991,00
UM414-1	14.5 D-2 UDRİL MATKAP			1.991,00
UM415	15 D-2 UDRİL MATKAP			1.991,00
UM415-1	15.5 D-2 UDRİL MATKAP	M2.2x5x3 TCM 10	SPMG 0602 TGTC / PLBT ZCC / KLP	1.991,00
UM416	16 D-2 UDRİL MATKAP			1.991,00
UM416-1	16.5 D-2 UDRİL MATKAP			1.991,00
UM417	17 D-2 UDRİL MATKAP			1.991,00
UM417-1	17.5 D-2 UDRİL MATKAP			1.991,00
UM418	18 D-2 UDRİL MATKAP			1.991,00
UM418-1	18.5 D-2 UDRİL MATKAP			1.991,00
UM419	19 D-2 UDRİL MATKAP			1.991,00
UM419-1	19.5 D-2 UDRİL MATKAP			1.991,00
UM420	20 D-2 UDRİL MATKAP			2.050,00
UM420-1	20.5 D-2 UDRİL MATKAP	2.050,00		
UM421	21 D-2 UDRİL MATKAP	M2.5x7x3.5 TCM 18	SPMG 07T3 TGTC / PLBT ZCC / KLP	2.050,00
UM421-1	21.5 D-2 UDRİL MATKAP			2.050,00
UM422	22 D-2 UDRİL MATKAP			2.050,00
UM422-1	22.5 D-2 UDRİL MATKAP			2.050,00
UM423	23 D-2 UDRİL MATKAP			2.050,00
UM423-1	23.5 D-2 UDRİL MATKAP			2.050,00
UM424	24 D-2 UDRİL MATKAP			2.050,00
UM424-1	24.5 D-2 UDRİL MATKAP			2.050,00
UM425	25 D-2 UDRİL MATKAP			2.050,00
UM425-1	25.5 D-2 UDRİL MATKAP			2.050,00
UM426	26 D-2 UDRİL MATKAP	2.050,00	2.050,00	
UM426-1	26.5 D-2 UDRİL MATKAP			
UM427	27 D-2 UDRİL MATKAP	2.050,00		

D-2 SPMG U-DRİLLER

KOD	ÜRÜN AÇIKLAMASI	YEDEKLER	UÇ TİPİ	FİYATI		
UM427-1	27.5 D-2 UDRİL MATKAP	M2.5x7x3.5	SPMG 07T3	2.177,00		
UM428	28 D-2 UDRİL MATKAP	M3.5x10x5.3 TCM 34	SPMG 0904 TGTC / PLBT ZCC / KLP	2.177,00		
UM428-1	28.5 D-2 UDRİL MATKAP			2.177,00		
UM429	29 D-2 UDRİL MATKAP			2.177,00		
UM429-1	29.5 D-2 UDRİL MATKAP			2.177,00		
UM430	30 D-2 UDRİL MATKAP			2.177,00		
UM431	31 D-2 UDRİL MATKAP			2.177,00		
UM432	32 D-2 UDRİL MATKAP			2.177,00		
UM433	33 D-2 UDRİL MATKAP			2.464,00		
UM434	34 D-2 UDRİL MATKAP			M4x11x5.3 TCM 42	SPMG 1104 TGTC / PLBT ZCC / KLP	2.464,00
UM435	35 D-2 UDRİL MATKAP					2.464,00
UM436	36 D-2 UDRİL MATKAP	2.464,00				
UM437	37 D-2 UDRİL MATKAP	2.464,00				
UM438	38 D-2 UDRİL MATKAP	2.464,00				
UM439	39 D-2 UDRİL MATKAP	2.464,00				
UM440	40 D-2 UDRİL MATKAP	2.464,00				
UM441	41 D-2 UDRİL MATKAP	2.545,00				
UM442	42 D-2 UDRİL MATKAP	M5x12x7 TCM 46	SPMG 1405 TGTC / PLBT ZCC / KLP			2.545,00
UM442-1	42.5 D-2 UDRİL MATKAP					2.545,00
UM443	43 D-2 UDRİL MATKAP			2.545,00		
UM444	44 D-2 UDRİL MATKAP			2.545,00		
UM445	45 D-2 UDRİL MATKAP			2.670,00		
UM446	46 D-2 UDRİL MATKAP			2.875,00		
UM447	47 D-2 UDRİL MATKAP			3.081,00		
UM448	48 D-2 UDRİL MATKAP			3.204,00		
UM449	49 D-2 UDRİL MATKAP			3.328,00		
UM450	50 D-2 UDRİL MATKAP			3.494,00		

D-3 SPMG U-DRİLLER

KOD	ÜRÜN AÇIKLAMASI	YEDEKLER	UÇ TİPİ	FİYATI		
UM512-1	12.5 D-3 UDRİL MATKAP	M2x5x2.7 TCM 06	SPMG 0502 TGTC / PLBT ZCC / KLP	2.134,00		
UM513	13 D-3 UDRİL MATKAP			2.134,00		
UM513-1	13.5 D-3 UDRİL MATKAP			2.134,00		
UM514	14 D-3 UDRİL MATKAP			2.134,00		
UM514-1	14.5 D-3 UDRİL MATKAP			2.134,00		
UM515	15 D-3 UDRİL MATKAP			2.134,00		
UM515-1	15.5 D-3 UDRİL MATKAP			2.134,00		
UM516	16 D-3 UDRİL MATKAP			M2.2x5x3 TCM 10	SPMG 0602 TGTC / PLBT ZCC / KLP	2.134,00
UM516-1	16.5 D-3 UDRİL MATKAP					2.134,00
UM517	17 D-3 UDRİL MATKAP					2.134,00
UM517-1	17.5 D-3 UDRİL MATKAP	2.134,00				
UM518	18 D-3 UDRİL MATKAP	2.134,00				
UM518-1	18.5 D-3 UDRİL MATKAP	2.134,00				
UM519	19 D-3 UDRİL MATKAP	2.134,00				
UM519-1	19.5 D-3 UDRİL MATKAP	2.134,00				
UM520	20 D-3 UDRİL MATKAP	2.260,00				
UM520-1	20.5 D-3 UDRİL MATKAP	2.260,00				
UM521	21 D-3 UDRİL MATKAP	2.260,00				
UM521-1	21.5 D-3 UDRİL MATKAP	2.260,00				

D-3 SPMG U-DRİLLER



KOD	ÜRÜN AÇIKLAMASI	YEDEKLER	UÇ TİPİ	FİYATI		
UM522	22 D-3 UDRİL MATKAP	M2.5x7x3.5 TCM 18	SPMG 07T3 TGTC / PLBT ZCC / KLP	2.260,00		
UM522-1	22.5 D-3 UDRİL MATKAP			2.260,00		
UM523	23 D-3 UDRİL MATKAP			2.260,00		
UM523-1	23.5 D-3 UDRİL MATKAP			2.260,00		
UM524	24 D-3 UDRİL MATKAP			2.301,00		
UM524-1	24.5 D-3 UDRİL MATKAP			2.301,00		
UM525	25 D-3 UDRİL MATKAP			2.301,00		
UM525-1	25.5 D-3 UDRİL MATKAP			2.301,00		
UM526	26 D-3 UDRİL MATKAP			2.301,00		
UM526-1	26.5 D-3 UDRİL MATKAP			2.301,00		
UM527	27 D-3 UDRİL MATKAP			2.301,00		
UM527-1	27.5 D-3 UDRİL MATKAP			2.301,00		
UM528	28 D-3 UDRİL MATKAP			M3.5x10x5.3 TCM 34	SPMG 0904 TGTC / PLBT ZCC / KLP	2.301,00
UM528-1	28.5 D-3 UDRİL MATKAP					2.301,00
UM529	29 D-3 UDRİL MATKAP	2.301,00				
UM529-1	29.5 D-3 UDRİL MATKAP	2.301,00				
UM530	30 D-3 UDRİL MATKAP	2.505,00				
UM531	31 D-3 UDRİL MATKAP	2.505,00				
UM532	32 D-3 UDRİL MATKAP	2.505,00				
UM533	33 D-3 UDRİL MATKAP	2.505,00				
UM534	34 D-3 UDRİL MATKAP	M4x11x5.3 TCM 42	SPMG 1104 TGTC / PLBT ZCC / KLP	2.505,00		
UM535	35 D-3 UDRİL MATKAP			2.505,00		
UM536	36 D-3 UDRİL MATKAP			2.505,00		
UM537	37 D-3 UDRİL MATKAP			2.505,00		
UM538	38 D-3 UDRİL MATKAP			2.505,00		
UM538-1	38.5 D-3 UDRİL MATKAP			2.505,00		
UM539	39 D-3 UDRİL MATKAP			2.505,00		
UM540	40 D-3 UDRİL MATKAP			2.505,00		
UM541	41 D-3 UDRİL MATKAP			2.792,00		
UM541-1	41.5 D-3 UDRİL MATKAP			2.792,00		
UM542	42 D-3 UDRİL MATKAP	M5x12x7 TCM 46	SPMG 1405 TGTC / PLBT ZCC / KLP	2.792,00		
UM543	43 D-3 UDRİL MATKAP			2.792,00		
UM544	44 D-3 UDRİL MATKAP			2.792,00		
UM545	45 D-3 UDRİL MATKAP			2.917,00		
UM546	46 D-3 UDRİL MATKAP			3.081,00		
UM547	47 D-3 UDRİL MATKAP			3.204,00		
UM548	48 D-3 UDRİL MATKAP			3.367,00		
UM549	49 D-3 UDRİL MATKAP			3.494,00		
UM550	50 D-3 UDRİL MATKAP			3.738,00		
UM550-1	50.5 D-3 UDRİL MATKAP			3.818,00		

D-4 SPMG U-DRİLLER

KOD	ÜRÜN AÇIKLAMASI	YEDEKLER	UÇ TİPİ	FİYATI
UM613	13 D-4 UDRİL MATKAP	M2x5x2.7 TCM 06	SPMG 0502 TGTC / PLBT ZCC / KLP	2.629,00
UM614	14 D-4 UDRİL MATKAP			2.629,00
UM614-1	14.5 D-4 UDRİL MATKAP			2.629,00
UM615	15 D-4 UDRİL MATKAP			2.629,00
UM615-1	15.5 D-4 UDRİL MATKAP			2.629,00
UM616	16 D-4 UDRİL MATKAP	M2.2x5x3 TCM 10	SPMG 0602 TGTC / PLBT ZCC / KLP	2.629,00
UM617	17 D-4 UDRİL MATKAP			2.629,00
UM617-1	17.5 D-4 UDRİL MATKAP			2.629,00
UM618	18 D-4 UDRİL MATKAP			2.629,00
UM619	19 D-4 UDRİL MATKAP			2.629,00
UM619-1	19.5 D-4 UDRİL MATKAP			2.629,00
UM620	20 D-4 UDRİL MATKAP			2.754,00
UM621	21 D-4 UDRİL MATKAP			2.754,00
UM622	22 D-4 UDRİL MATKAP	M2.5x7x3.5 TCM 18	SPMG 07T3 TGTC / PLBT ZCC / KLP	2.754,00
UM623	23 D-4 UDRİL MATKAP			2.754,00
UM623-1	23.5 D-4 UDRİL MATKAP			2.754,00
UM624	24 D-4 UDRİL MATKAP			2.875,00
UM624-1	24.5 D-4 UDRİL MATKAP			2.875,00
UM625	25 D-4 UDRİL MATKAP			2.875,00
UM626	26 D-4 UDRİL MATKAP			2.875,00
UM627	27 D-4 UDRİL MATKAP			2.875,00
UM627-1	27.5 D-4 UDRİL MATKAP			2.875,00
UM628	28 D-4 UDRİL MATKAP			M3.5x10x5.3 TCM 34
UM629	29 D-4 UDRİL MATKAP	2.875,00		
UM630	30 D-4 UDRİL MATKAP	3.120,00		
UM631	31 D-4 UDRİL MATKAP	3.120,00		
UM632	32 D-4 UDRİL MATKAP	3.120,00		
UM633	33 D-4 UDRİL MATKAP	3.120,00		
UM633-1	33.5 D-4 UDRİL MATKAP	3.120,00		
UM634	34 D-4 UDRİL MATKAP	M4x11x5.3 TCM 42	SPMG 1104 TGTC / PLBT ZCC / KLP	3.120,00
UM635	35 D-4 UDRİL MATKAP			3.120,00
UM636	36 D-4 UDRİL MATKAP			3.120,00
UM637	37 D-4 UDRİL MATKAP			3.120,00
UM638	38 D-4 UDRİL MATKAP			3.120,00
UM638-1	38.5 D-4 UDRİL MATKAP			3.120,00
UM639	39 D-4 UDRİL MATKAP			3.120,00
UM639-1	39.5 D-4 UDRİL MATKAP			3.120,00
UM640	40 D-4 UDRİL MATKAP			3.120,00
UM641	41 D-4 UDRİL MATKAP			3.367,00

D-4 SPMG U-DRİLLER



KOD	ÜRÜN AÇIKLAMASI	YEDEKLER	UÇ TİPİ	FİYATI
UM642	42 D-4 UDRİL MATKAP	M5x12x7 TCM 46	SPMG 1405 TGTC / PLBT ZCC / KLP	3.367,00
UM643	43 D-4 UDRİL MATKAP			3.367,00
UM644	44 D-4 UDRİL MATKAP			3.367,00
UM645	45 D-4 UDRİL MATKAP			3.367,00
UM646	46 D-4 UDRİL MATKAP			3.530,00
UM647	47 D-4 UDRİL MATKAP			3.738,00
UM648	48 D-4 UDRİL MATKAP			3.985,00
UM649	49 D-4 UDRİL MATKAP			4.105,00
UM650	50 D-4 UDRİL MATKAP			4.516,00

D-5 SPMG U-DRİLLER



KOD	ÜRÜN AÇIKLAMASI	YEDEKLER	UÇ TİPİ	FİYATI
UM716	16 D-5 UDRİL MATKAP	M2.2x5x3 TCM 10	SPMG 0602 TGTC / PLBT ZCC / KLP	3.204,00
UM717	17 D-5 UDRİL MATKAP			3.204,00
UM718	18 D-5 UDRİL MATKAP			3.204,00
UM719	19 D-5 UDRİL MATKAP			3.204,00
UM720	20 D-5 UDRİL MATKAP			3.367,00
UM721	21 D-5 UDRİL MATKAP			3.367,00
UM722	22 D-5 UDRİL MATKAP	M2.5x7x3.5 TCM 18	SPMG 07T3 TGTC / PLBT ZCC / KLP	3.367,00
UM723	23 D-5 UDRİL MATKAP			3.530,00
UM724	24 D-5 UDRİL MATKAP			3.530,00
UM725	25 D-5 UDRİL MATKAP			3.530,00
UM726	26 D-5 UDRİL MATKAP			3.530,00
UM727	27 D-5 UDRİL MATKAP			3.530,00
UM728	28 D-5 UDRİL MATKAP	M3.5x10x5.3 TCM 34	SPMG 0904 TGTC / PLBT ZCC / KLP	3.697,00
UM729	29 D-5 UDRİL MATKAP			3.697,00
UM730	30 D-5 UDRİL MATKAP			3.697,00

YEDEKLER

ÇEKTİRME LEVYESİ

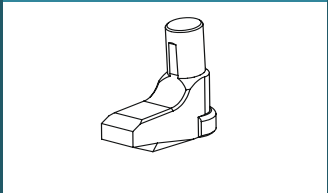

KOD	ÜRÜN AÇIKLAMASI	FİYATI
MPL011	LEVYE P- DN_11/TN_16/WN_06	108,00
MPL012	LEVYE P- CN_12/DN_15/WN_08/TN_22	108,00
MPL016	LEVYE P- CN_16/SN_15	108,00
MPL019	LEVYE P- CN_19/SN_19	108,00

ALTLIK SACI



KOD	ÜRÜN AÇIKLAMASI	FİYATI
MPS011	ALTLIK SACI -P DN_11/TN_16/WN_06	34,00
MPS012	ALTLIK SACI -P CN_12/DN_15/TN_22/WN_08	34,00
MPS016	ALTLIK SACI -P CN_16/SN_15	34,00
MPS019	ALTLIK SACI -P CN_19/SN_19	34,00

ÇEKTİRME VİDASI



KOD	ÜRÜN AÇIKLAMASI	FİYATI
TCM72	MPV M8 K P SİSTEM VİDASI	78,00
TCM74	MPV M8 U P SİSTEM VİDASI	78,00

KEP BASKI VİDASI

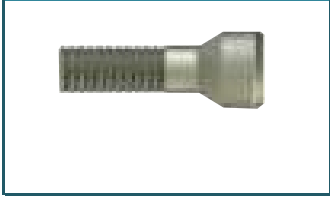

KOD	ÜRÜN AÇIKLAMASI	FİYATI
TCM49	M5x23 A3 KEP VİDASI	39,00
TCM50	M6x27 A3 KEP VİDASI	39,00
TCM51	M8x25 A5 KEP VİDASI	72,00

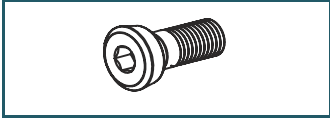
KESME KATER VİDASI

KOD	ÜRÜN AÇIKLAMASI	FİYATI
TCM80	M4x12 A3 KESME KATER VİDASI	23,00
TCM82	M5x16 A3 KESME KATER VİDASI	29,00
TCM84	M6x16 A5 KESME KATER VİDASI	39,00
TCM86	M8x26 A4 KESME KATER VİDASI	39,00

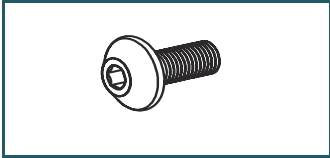

TCM55	M8X1.25 SPKN 12 VİDASI	78,00
-------	------------------------	-------



TCM56	M6x0.75 TPKN 16 VİDASI	39,00
TCM57	M8x1 TPKN 22 VİDASI	51,00

KÜRE TAKIM VİDASI

KOD	ÜRÜN AÇIKLAMASI	FİYATI
TCM64	M3x7 D08 KÜRE TAKIM VİDASI	69,00
TCM65	M4x9 D10 KÜRE TAKIM VİDASI	69,00
TCM66	M5x10 D12 KÜRE TAKIM VİDASI	69,00
TCM67	M5x12 D16 KÜRE TAKIM VİDASI	69,00
TCM68	M5x16 D20 KÜRE TAKIM VİDASI	69,00
TCM69	M5x22 D25 KÜRE TAKIM VİDASI	69,00
TCM70	M8x25 D30 KÜRE TAKIM VİDASI	69,00

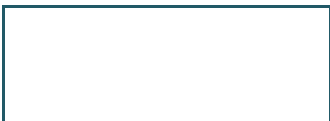

PİM01	5x3.6x15 PİM WN 06 / TN 16	34,00
PİM02	6x5x15 PİM WN 08 / TN 22	34,00
PİM03	6x5x18 PİM WN 08 / TN 22	34,00



PUL	T/M SİSTEMİ PUL 10x6x1mm	10,00
YAY	BASKI PABUÇ YAYI	10,00

TORX VİDALAR



KOD	ÜRÜN AÇIKLAMASI	FİYATI
TCM02	M1.8x4.2x2.4 TORX VİDA	72,00
TCM04	M2x4 TORX VİDA	23,00
TCM06	M2x5x2.7 TORX VİDA	23,00
TCM10	M2.2x5x3 TORX VİDA	23,00
TCM11	M2.2x6x3 TORX VİDA	23,00
TCM14	M2.5x5x3.5 TORX VİDA	23,00
TCM16	M2.5x6x3.5 TORX VİDA	23,00
TCM18	M2.5x7x3.5 TORX VİDA	23,00
TCM22	M2.5x10x3.5 TORX VİDA	23,00
TCM24	M3x6 TORX VİDA	23,00
TCM28	M3x8x4 LOGU TORX VİDA	23,00
TCM29	M3x8x4.2 TORX VİDA	23,00
TCM30	M3x10x4.2 TORX VİDA	23,00
TCM32	M3.5x8x4.8 TORX VİDA	23,00
TCM33	M3.5x8x5.3 TORX VİDA	23,00
TCM34	M3.5x10x5.3 TORX VİDA	23,00
TCM35	M3.5x11x4.8 TORX VİDA	23,00
TCM36	M3.5x11x6.3 TORX VİDA	23,00
TCM38	M3.5x14x5.3 TORX VİDA	23,00
TCM39	M3.5x14x4.8 TORX VİDA	23,00
TCM40	M4x9x5.4 TORX VİDA	23,00
TCM41	M4x10x5.8 TORX VİDA	23,00
TCM42	M4x11x5.3 TORX VİDA	23,00
TCM43	M4x14x5.3 TORX VİDA	23,00
TCM44	M4x16x5.5 TORX VİDA	23,00
TCM45	M4x14x7.0 SNKX WLTR VİDA	23,00
TCM87	M4.5x12x6.5 TORX VİDA	23,00
TCM89	M4.5x17x6,5 TORX VİDA	23,00
TCM46	M5x12x7.0 TORX VİDA	23,00
TCM47	M5x15x6.5 TORX VİDA	23,00

ALTLIK VİDALAR



KOD	ÜRÜN AÇIKLAMASI	FİYATI
TCM58	M3x10 ALTLIK VİDASI	23,00
TCM60	M4x10 ALTLIK VİDASI	23,00
TCM62	M5x10 ALTLIK VİDASI	23,00
TCM63	M6x10 ALTLIK VİDASI	23,00
TCM76	M5x0.5x3.5x11 BUKSE VİDASI	51,00
TCM78	M6x0.75x4x11 BUKSE VİDASI	51,00

ALTLIKLAR

KOD	ÜRÜN AÇIKLAMASI	FİYATI
TAM01	T/P SİSTEMİ ALTLIK DNMG 11	78,00
TAM02	T/P SİSTEMİ ALTLIK DNMG 15	90,00
TAM03	T/P SİSTEMİ ALTLIK CNMG 12	78,00
TAM05	T/P SİSTEMİ ALTLIK CNMG 16	111,00
TAM06	T/P SİSTEMİ ALTLIK CNMG 19	134,00
TAM04	T/P SİSTEMİ ALTLIK VNMG 16	84,00
TAM07	T/P SİSTEMİ ALTLIK SNMG 12	78,00
TAM08	T/P SİSTEMİ ALTLIK SNMG 15	111,00
TAM09	T/P SİSTEMİ ALTLIK SNMG 19	134,00
TAM24	T/P SİSTEMİ ALTLIK TNMG 16	84,00
TAM25	T/P SİSTEMİ ALTLIK TNMG 22	117,00
TAM12	T/M SİSTEMİ ALTLIK WNMG 08	90,00
TAM10	M/P SİSTEMİ ALTLIK TNMG 16	84,00
TAM11	M/P SİSTEMİ ALTLIK TNMG 22	117,00
TAM13	S SİSTEMİ ALTLIK DCMT 11	78,00
TAM14	S SİSTEMİ ALTLIK VBMT 16	84,00
TAM15	S SİSTEMİ ALTLIK VCMT 16	84,00
TAM16	S SİSTEMİ ALTLIK TCMT 16	81,00
TAM17	S SİSTEMİ ALTLIK CCMT 12	78,00
TAM18	DİŞ ALTLIGI 16 SER-SEL/SIR-SIL	108,00
TAM19	DİŞ ALTLIGI SAĞ 22 SER-SIL	108,00
TAM20	DİŞ ALTLIGI 22 SEL-SIR	108,00
TAM21	C SİSTEMİ ALTLIK KNUX 16-R	107,00
TAM22	C SİSTEMİ ALTLIK KNUX 16-L	107,00
TAM23	TPKN 16 ALTLIK	107,00

BASKI KEPLERİ



KOD	ÜRÜN AÇIKLAMASI	FİYATI
KEP01	T110105 DNMG 11 BASKI KEPİ	78,00
KEP02	T150105 DNMG 15 BASKI KEPİ	102,00
KEP03	T160105 CNMG 16 BASKI KEPİ	115,00
KEP04	T190105 CNMG 19 BASKI KEPİ	130,00
KEP19	T160105 VNMG 16 BASKI KEPİ	115,00
KEP05	M060105 WNMG 06 BASKI KEPİ	78,00
KEP06	M080105 WNMG 08 BASKI KEPİ	107,00
KEP07	M160105 TNMG 16 BASKI KEPİ	102,00
KEP08	M220105 TNMG 22 BASKI KEPİ	102,00
KEP17	C110105 TPKN 11 BASKI KEPİ	107,00
KEP18	C160105 TPKN 16 BASKI KEPİ	107,00
KEP12	CK14 BASKI KEPİ	108,00
KEP13	CK15 BASKI KEPİ	108,00
KEP09	C160105 KNUX 16-R BASKI KEPİ	108,00
KEP10	C160105 KNUX 16-L BASKI KEPİ	108,00
KEP14	DIŞ SAÇ BASKI KEPİ KNUX 16-R	90,00
KEP15	DIŞ SAÇ BASKI KEPİ KNUX 16-L	90,00
KEP16	İÇ SAÇ BASKI KEPİ KNUX 16	90,00